

HYDRAULIC FILTRATION PRODUCTS

SPIN-ON FILTERS



PASSION TO PERFORM





A WORLDWIDE LEADER IN THE FIELD OF HYDRAULIC FILTRATION EQUIPMENT.

Our company started life in 1964, when Bruno Pasotto decided to attempt to cater for the requests of a market still to be fully explored, with the study, design, development, production and marketing of a vast range of filters for hydraulic equipment, capable of satisfying the needs of manufacturers in all sectors. The quality of our products, our extreme competitiveness compared with major international producers and our constant activities of research, design and development has made us a worldwide leader in the field of hydraulic circuit filtering. Present for over 50 years in the market, we have played a truly decisive role in defining our sector, and by now we are a group capable of controlling our entire chain of production, monitoring all manufacturing processes to guarantee superior quality standards and to provide concrete solutions for the rapidly evolving needs of customers and the market.

MARKET LEADER



Our work is based on a skillful interaction between advanced technology and fine workmanship, **customizing products according to specific market requests**, focusing strongly on innovation and quality, and following every step in the manufacturing of both standard and special products, fully respecting customer expectations.



Our customer-oriented philosophy, which enables us to satisfy all customer requests **rapidly and with personalized products**, makes us a **dynamic and flexible enterprise**. The possibility of constantly controlling and monitoring the entire production process is essential to allow us to guarantee the quality of our products.

WORLDWIDE PRESENCE

Our foreign Branches enable us to offer a diversified range of products that allow us to successfully face the aggressive challenge of international competition, and also to maintain a stable presence at a local level.

The Group boasts **8** business branches



TECHNOLOGY

Our constant **quest for excellence in quality and technological innovation** allows us to offer only the best solutions and services for applications in many fields, including general industry, test rigs, lubrication, heavy engineering, renewable energies, naval engineering, offshore engineering, aviation systems, emerging technologies and mobile plant (i.e. tractors, excavators, concrete pumps, platforms).



AND PRODUCTION

Our high level of technological expertise means **we can rely entirely on our own resources, without resorting to external providers.** This in turn enables us to satisfy a growing number of customer requests, also exploiting our constantly updated range of machines and equipment, featuring **fully-automated workstations** capable of **24-hour production.**

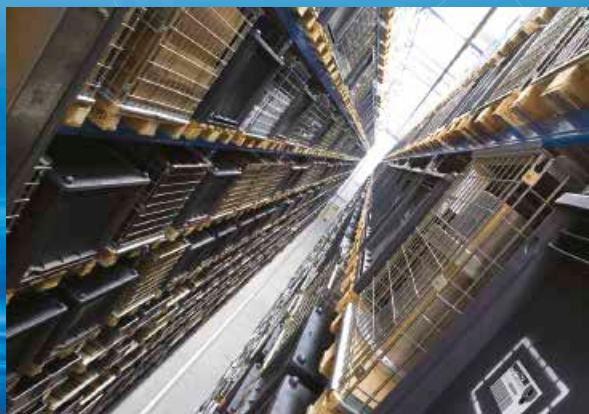



SUCTION FILTERS

Flow rates
up to 875 l/min

Mounting:
- Tank immersed
- In-Line
- In tank with
shut off valve
- In tank
with flooded suction

RETURN FILTERS

Flow rates
up to 3000 l/min

Pressure
up to 20 bar

Mounting:
- In-Line
- Tank top
- In single
and duplex designs

RETURN / SUCTION FILTERS

Flow rates
up to 300 l/min

Pressure
up to 80 bar

Mounting:
- In-Line
- Tank top

SPIN-ON FILTERS

Flow rates
up to 365 l/min

Pressure
up to 35 bar

Mounting:
- In-Line
- Tank top

LOW & MEDIUM PRESSURE FILTERS

Flow rates
up to 3000 l/min

Pressure
up to 80 bar

Mounting:
- In-Line
- Parallel manifold version
- In single
and duplex designs

HIGH PRESSURE FILTERS

Flow rates
up to 750 l/min

Pressure from 110 bar
up to 560 bar

Mounting:
- In-Line
- Manifold
- In single
and duplex designs

PRODUCT RANGE

MP Filtri can offer a vast and articulated range of products for the global market, suitable for all industrial sectors using hydraulic equipment.

This includes filters (suction, return, return/suction, spin-on, pressure, stainless steel pressure) and structural components (motor/pump bell-housings, transmission couplings, damping rings, foot brackets, aluminium tanks, cleaning covers).

We can provide all the skills and solutions required by the modern hydraulics industry to monitor contamination levels and other fluid conditions.

Mobile filtration units and a full range of accessories allow us to supply everything necessary for a complete service in the hydraulic circuits.



STAINLESS STEEL HIGH PRESSURE FILTERS

Flow rates
up to 125 l/min

Pressure from 320 bar
up to 1000 bar

Mounting:

- In-Line
- Manifold
- In single
and duplex designs

CONTAMINATION MONITORING PRODUCTS

- Online, in-line particle counters
- Off-line bottle sampling
products
- Fully calibrated using relevant
ISO standards
- A wide range of variants to
support fluid types and
communication protocols

MOBILE FILTRATION UNITS

Flow rates from 15 l/min
up to 200 l/min

POWER TRANSMISSION PRODUCTS

- Aluminium bell-housings
for motors
from 0.12 kW to 400 kW
- Couplings in Aluminium
Cast Iron - Steel
- Damping rings
- Foot bracket
- Aluminium tanks
- Cleaning covers

TANK ACCESSORIES

- Oil filler and
air breather plugs
- Optical and electrical
level gauges
- Pressure gauge valve
selectors
- Pipe fixing brackets
- Pressure gauges

HYDRAULIC FILTRATION PRODUCTS

1	page	INTRODUCTION
1		COMPANY
6		PRODUCT RANGE
11		CONTAMINATION MANAGEMENT
22		FILTER SIZING
24		CORRECTIVE FACTOR

28	page	SUCTION FILTERS			up to Q_{max}
					l/min gpm
31	STR & MPA - MPM	Submerged suction filter, with bypass or magnetic filter			1000 264
39	SF2 250 - 350	Semi-submerged positive head suction filter, low flow rate			160 42
47	SF2 500	Semi-submerged positive head suction filter, high flow rate			700 185
57		CLOGGING INDICATORS			

60	page	RETURN FILTERS		up to P_{max}	up to Q_{max}
			bar psi	l/min gpm	
63	MPFX	Tank top semi-immersed filter, standard filter element disassembly	8 116	900 238	
91	MPLX	Tank top semi-immersed filter, standard filter element disassembly	10 145	1800 476	
99	MPTX	Tank top semi-immersed filter, easy filter element disassembly	8 116	300 79	
117	MFBX	Bowl assembly	8 116	700 185	
125	MPF	Tank top semi-immersed filter, standard filter element disassembly	8 116	900 238	
153	MPT	Tank top semi-immersed filter, easy filter element disassembly	8 116	300 79	
171	MFB	Bowl assembly	8 116	700 185	
179	MPH	Tank top semi-immersed filter, standard filter element disassembly	10 145	3500 925	
203	MPI	Tank top semi-immersed filter, standard filter element disassembly	10 145	3500 925	
215	FRI	Tank top semi-immersed filter, easy filter element disassembly, it can be used also as in-line filter	20 290	2500 660	
231	RF2	Semi-immersed under-head filter, easy filter element disassembly	20 290	615 162	
238		CLOGGING INDICATORS			
248		ACCESSORIES			

250	page	RETURN / SUCTION FILTERS		up to P_{max}	up to Q_{max}
			bar psi	l/min gpm	
253	MRSX	Unique TANK TOP filter for mobile machinery, with combined filtration on return and suction to the inlet at the hydrostatic transmissions in closed circuit	10 145	250 66	
265	LMP 124 MULTIPORT	Unique IN-LINE filter for mobile machinery, with combined filtration on return and suction to the inlet at the hydrostatic transmissions in closed circuit	80 1160	120 32	
273		CLOGGING INDICATORS			

286	page	SPIN-ON FILTERS		up to P_{max}	up to Q_{max}
			bar psi	l/min gpm	
289	MPS	Low pressure filter, available with single cartridge (CS) for in-line or flange mounting or with two cartridge on the same axis on the opposite sides	12 174	365 96	
305	MSH	In-line low and medium pressure filter available with single cartridge (CH)	35 508	195 52	
311		CLOGGING INDICATORS			

322 page LOW & MEDIUM PRESSURE FILTERS			up to P _{max}		up to Q _{max}	
			bar	psi	l/min	gpm
325	LMP 110 - 120 - 123 MULTIPORT	In-line filter with Multiport design for multiple choice connection	80	1160	175	46
341	LMP 210 - 211	In-line low & medium pressure filter, low flow rate	60	870	365	96
351	LMP 400 - 401 & 430 - 431	In-line low & medium pressure filter, high flow rate	60	870	780	206
363	LMP 950 - 951	In-line filter, available with 2 and up to 6 different heads	30	435	2400	634
371	LMP 952 - 953 - 954	In-line low pressure filter specifically designed to be mounted in series	25	363	4500	1189
383	LMD 211	In-line duplex medium pressure filter	60	870	200	53
391	LMD 400 - 401 & 431	In-line duplex low pressure filter	16	232	600	159
407	LMD 951	In-line duplex filter, available with 2 up to 6 different heads	16	232	1200	317
415		Filter elements designed according to DIN 24550				
417	LDP - LDD	In-line and duplex medium pressure filter	60	870	360	95
427	LMP 900 - 901	In-line low pressure filter	30	435	2000	528
435	LMP 902 - 903	In-line filter specifically designed to be mounted in series	20	290	3000	793
444	CLOGGING INDICATORS					
450	ACCESSORIES					

452 page HIGH PRESSURE FILTERS			up to P _{max}		up to Q _{max}	
			bar	psi	l/min	gpm
455	FMP 039	Filter high pressure, low flow rate applications	110	1595	80	21
463	FMP	Filter high pressure, high flow rate applications	320	4641	500	132
475	FHP	Typical high pressure filter for mobile applications, high flow rate	420	6092	630	166
493	FMM	Typical high pressure filter for mobile applications, low flow rate	420	6092	300	79
503	HPB	Pressure filter kits for integration in control manifolds	420	6092	300	79
513	FHA 051	Filter optimized for use in high pressure operating systems, low flow rate	560	8122	150	40
521	FHM	High pressure filter with intermediate manifold construction	320	4641	400	106
539	FHB	High pressure for block mounting	320	4641	485	128
553	FHF 325	In-line manifold top mounting	350	5076	550	145
563	FHD	In-line duplex high pressure filter	350	5076	250	66
576	CLOGGING INDICATORS					

584 page STAINLESS STEEL HIGH PRESSURE FILTERS			up to P _{max}		up to Q _{max}	
			bar	psi	l/min	gpm
587	FZP	In-line pressure filter with threaded mount	420	6092	160	42
597	FZH	In-line pressure filter with threaded mount for higher pressure	700	10153	80	21
607	FZX	In-line pressure filter with threaded mount up to 1000 bar	1000	14504	10	3
615	FZM	Manifold top mounting	320	4641	70	18
623	FZB	Manifold side mounting	320	4641	70	18
631	FZD	Duplex pressure filter for continuous operation requirements	350	5076	60	16
641	CLOGGING INDICATORS					

646 page CLOGGING INDICATORS		
649	QUICK REFERENCE GUIDE	

TYPICAL FILTER SIZING Selection Software

Step 1 Select "FILTERS"

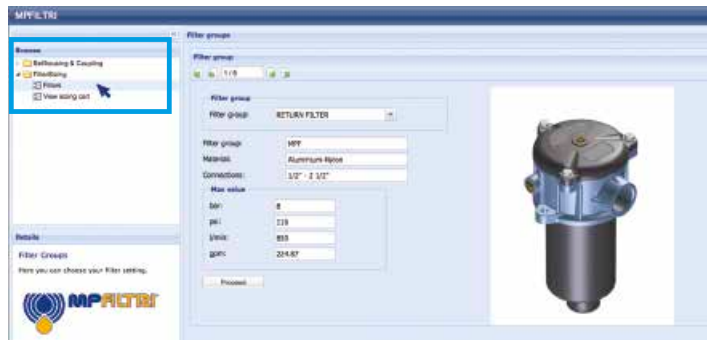

Step 2 Choose filter group (Return Filter, Pressure Filter, etc.)



Step 3 Choose filter type (MPF, MPT, etc.) in function of the max working pressure and the max flow rate



Step 4 Push "PROCEED"

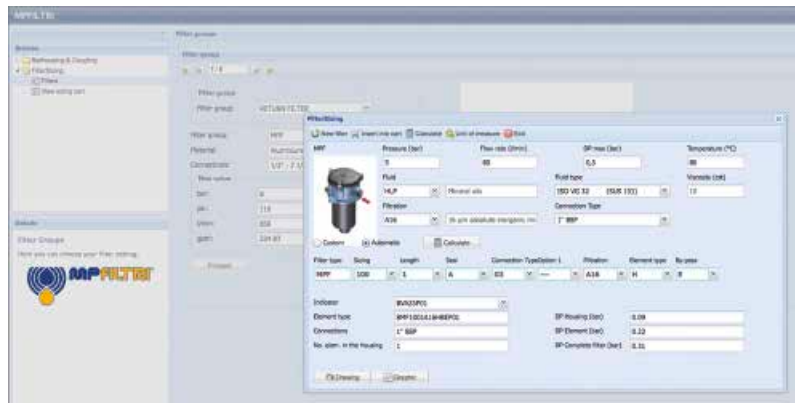
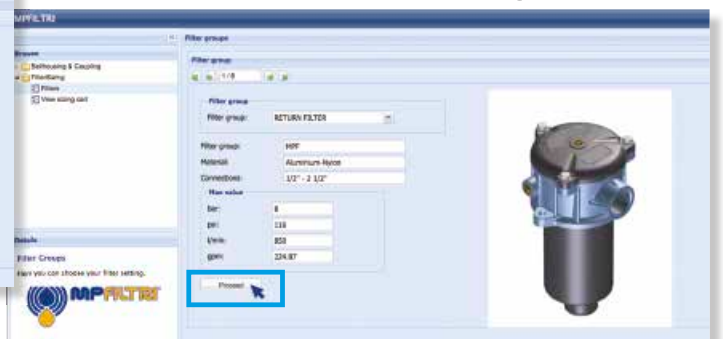

Step 5

Insert all application data to calculate the filter size following the sequence:

- working pressure
- working flow rate
- working pressure drop
- working temperature
- fluid material and fluid type
- filtration media
- connection type

Step 6

Push "CALCULATE" to have result; in case of any mistake, the system will advice which parameter is out of range to allow to modify/adjust the selection



Step 7

Download PDF Datasheet "Report.aspx" pushing the button "Drawing"

Spin-On filters are used as process and safety filters to protect individual pumps, valves or the entire hydraulic circuit from contamination as per ISO 4406.

In-line Spin-On filters can be used for the following purposes:

- **Suction filters**
- **On the return circuit, for mounting on the line or on the tank cover**
- **In-line for low and medium pressure applications**

Spin-On filters are available in 4 configurations:

- **Single cartridge in-line**
- **In-line with two parallel cartridges on the same axis**
- **In-line with two parallel cartridges mounted side by side**

All versions may be equipped with visual and/or electrical blockage indicators.

Spin-on filters



MPS	page 289
MSH	305
INDICATORS	311

MPS series

Maximum working pressure up to 1.2 MPa (12 bar) - Flow rate up to 365 l/min



Spin-on filters

Maximum working pressure up to 1.2 MPa (12 bar)

Flow rate up to 365 l/min

MPS is a range of spin-on filters suitable to be used in suction, return and low pressure lines.

They offer a good balance between performances, dimensions and prices. They are directly connected to the lines of the system through the hydraulic fittings.

Available features:

- Female threaded connections up to 1 1/2" and flanged connections up to 1 1/2", for a maximum flow rate of 365 l/min
- Fine filtration rating, to get a good cleanliness level into the reservoir
- Water removal elements (CW), to remove the free water from the hydraulic fluid
- Double connection for the cans, to fit both European and American standard elements
- Double cans fitting, to increase the life time of the filter
- Bypass valve, to relieve excessive pressure drop across the filter media
- Visual, electrical and electronic clogging indicators for suction and return applications
- Visual, electrical and electronic differential clogging indicators for low pressure applications

Common applications:

- Suction lines, Return lines, Delivery lines, in economic industrial equipment or mobile machines.
- Off-line filtration tank in economic industrial equipment or mobile machines

Filter housing materials

- Head: Aluminium
- Bypass valve: Nylon - Steel
- Element: Zinc-Plated Steel - Painted Steel

Bypass valve

- Return filter opening pressure: 175 kPa (1.75 bar) $\pm 10\%$
- Suction filter opening pressure: 30 kPa (0.3 bar) $\pm 10\%$

Δp element type

- Δp : 5 bar
- Fluid flow through the filter element from OUT to IN

Seals

Standard NBR - series A

Temperature

From -20 °C to +110 °C

Note

MPS filters are provided for vertical mounting



Weights [kg] and volumes [dm³]

Filter series	Weights [kg]	Volumes [dm ³]
MPS 050	1.00	0.70
MPS 051	1.05	0.70
MPS 070	1.20	0.95
MPS 071	1.25	0.95
MPS 100	2.10	1.65
MPS 101	2.20	1.65
MPS 150	2.40	2.00
MPS 151	2.50	2.00
MPS 200	3.90	3.00
MPS 250	4.60	3.70
MPS 300-301	5.30	3.40
MPS 350-351	6.00	4.10

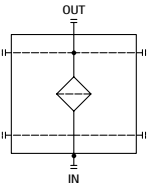
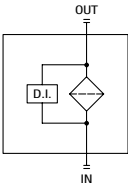
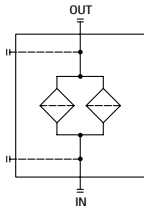
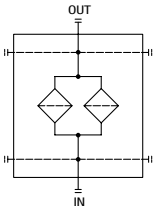
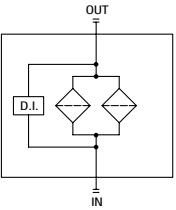
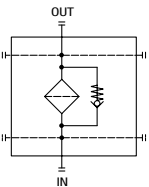
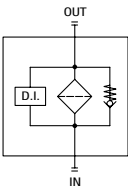
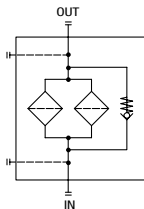
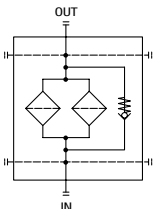
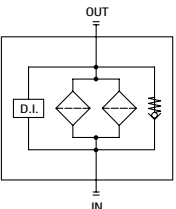
Filter series					
MPS 050	•				
MPS 051		•			
MPS 070	•				
MPS 071		•			
MPS 100	•				
MPS 101		•			
MPS 150	•				
MPS 151		•			
MPS 200			•		
MPS 250			•		
MPS 300				•	
MPS 301				•	•
MPS 350				•	
MPS 351					•
	Style U/P	Style U/P	Style U	Style U/P	Style U/P
					
	Style R/S	Style R/S	Style R/S	Style R/S	Style R/S
					

Pressure drop

Bypass valve
pressure drop

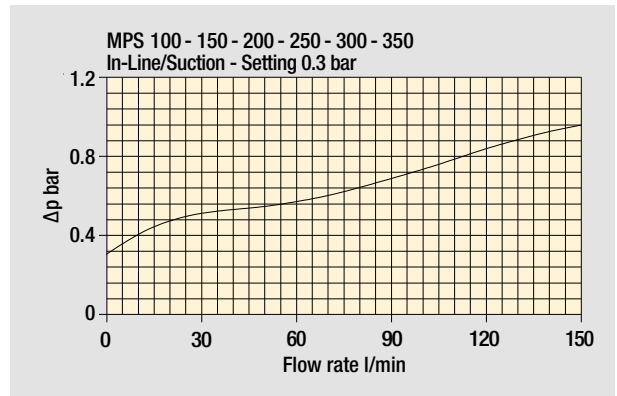
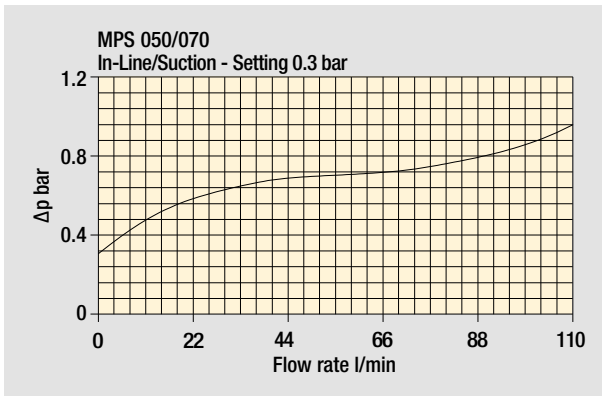
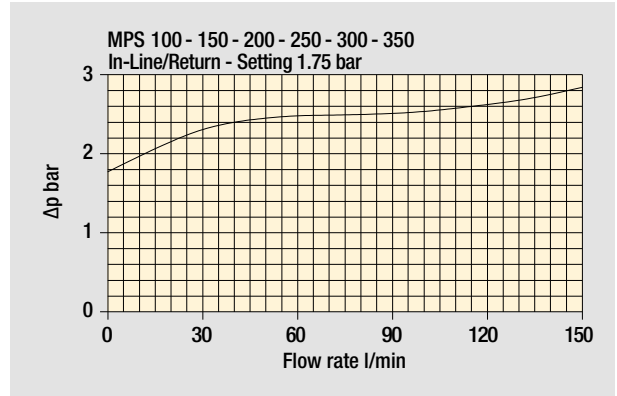
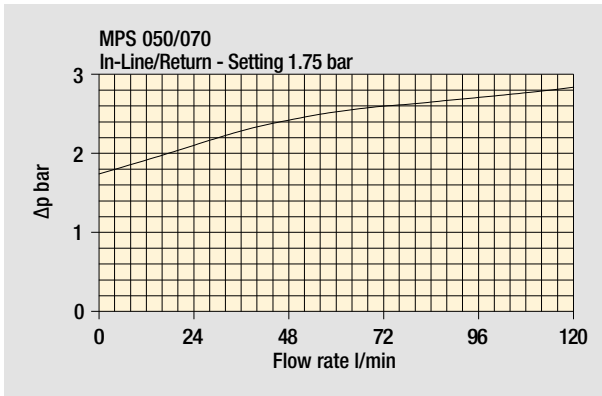

The curves are plotted using mineral oil with density of 0.86 kg/dm³ in compliance with ISO 3968. Δp varies proportionally with density.

CS 050 - 070 - 100 - 150

CG - CW 050 - 070



CG - CW 100 - 150



CW

This series of cartridge removes water from oil while filtering the oil at the same time.

Water absorbent polymers up to 800 times their own weight provide this major feature.

Water holding capacities:

CW 050= 240 ml

Ordering code: **CW050P10AP01**

CW 150= 788 ml

Ordering code: **CW150P10AP01**

Thread connections

Element	Connection
CS 050 - 070	G 3/4"
CS 100 - 150	G 1 1/4"
CG / CW 050 - 070	1" - 12 UNF
CG / CW 100 - 150	1 1/2" - 16 UN

Water holding capacities CW

	good	poor
Viscosity	30/46 mm ² /s (cSt)	> 46 mm ² /s (cSt)
H₂O p.p.m.	600/800 p.p.m.	> 800 p.p.m.
Flow rate	CW050 7/15 l/min CW150 20/40 l/min	CW050 > 20 l/min CW150 > 50 l/min
Temperature	40/60 °C	< 30 °C

Heads

CG / CW
1" - 12 UNF

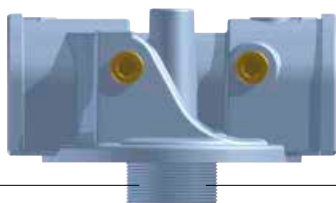

CS
G 3/4"

CG / CW
1 1/2" - 16 UN

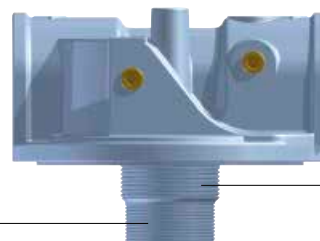

CS
G 1 1/4"

MPS MPS050 - MPS070 MPS051 - MPS071

Designation & Ordering code

COMPLETE FILTER

Series and size		Configuration example: MPS050 R G1 A10 A P01				
MPS050 MPS070	With connections for clogging indicators					
MPS051 MPS071	With connections for differential indicators					
Bypass valve		MPS 050 - 070	MPS 051 - 071			
R	Return: 1.75 bar	•	•			
S	Suction: 30 kPa	•				
U	Without bypass	•				
P	Without bypass		•			
Connections						
G1	G 3/4"					
G2	3/4" NPT					
G3	SAE 12 - 1 1/16" - 12 UN					
Filtration rating (filter media)						
A03	Inorganic microfiber 3 µm					
A06	Inorganic microfiber 6 µm					
A10	Inorganic microfiber 10 µm					
A25	Inorganic microfiber 25 µm					
	M25 Wire mesh 25 µm					
	M60 Wire mesh 60 µm					
	M90 Wire mesh 90 µm					
	P10 Resin impregnated paper 10 µm					
	P25 Resin impregnated paper 25 µm					
				Seal		Execution
				A NBR		P01 MP Filtri standard

CARTRIDGE

Cartridge series and size		Configuration example: CS050 A10 A P01			
CS050 CS070					
Filtration rating (filter media)					
A03	Inorganic microfiber 3 µm				
A06	Inorganic microfiber 6 µm				
A10	Inorganic microfiber 10 µm				
A25	Inorganic microfiber 25 µm				
	M25 Wire mesh 25 µm				
	M60 Wire mesh 60 µm				
	M90 Wire mesh 90 µm				
	P10 Resin impregnated paper 10 µm				
	P25 Resin impregnated paper 25 µm				
				Seals	Execution
				A NBR	P01 MP Filtri standard Pxx Customized

ACCESSORIES

Clogging indicators on RETURN line		page			page
BVA	Axial pressure gauge	315	BEA	Electrical pressure indicator	314
BVR	Radial pressure gauge	315	BEM	Electrical pressure indicator	314
BVP	Visual pressure indicator with automatic reset	316	BLA	Electrical / visual pressure indicator	314-315
BVQ	Visual pressure indicator with manual reset	316			
Clogging indicators on SUCTION line		page			page
VVB	Axial pressure gauge	313	VEB	Electrical vacuum indicator	312
VVS	Radial pressure gauge	313	VLB	Electrical/visual vacuum indicator	312
Differential indicators		page			page
DEA	Electrical differential indicator	317	DTA	Electronic differential indicator	320
DEM	Electrical differential indicator	317-318	DVA	Visual differential indicator	320
DLA	Electrical / visual differential indicator	318-319	DVM	Visual differential indicator	320
DLE	Electrical / visual differential indicator	319			

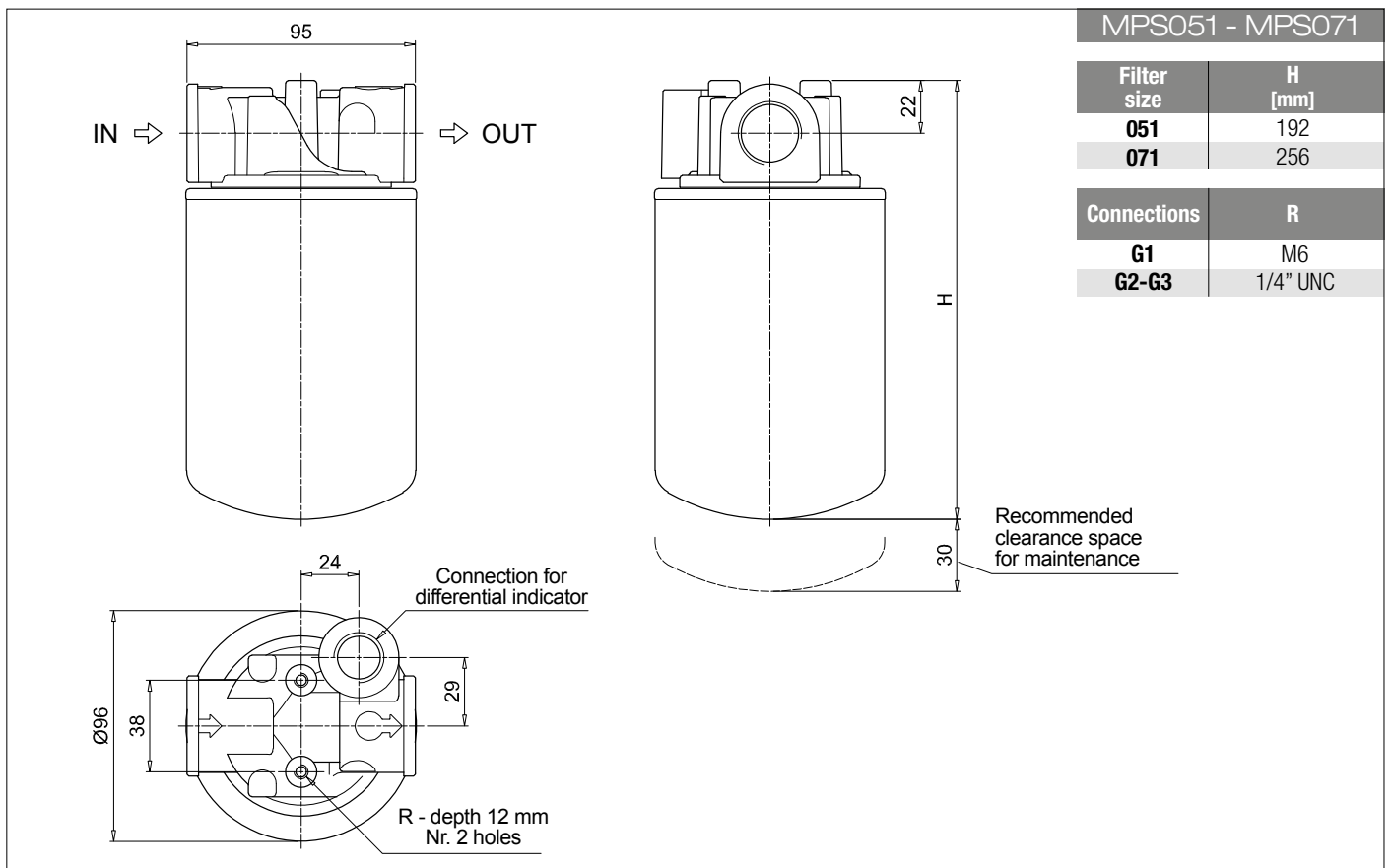
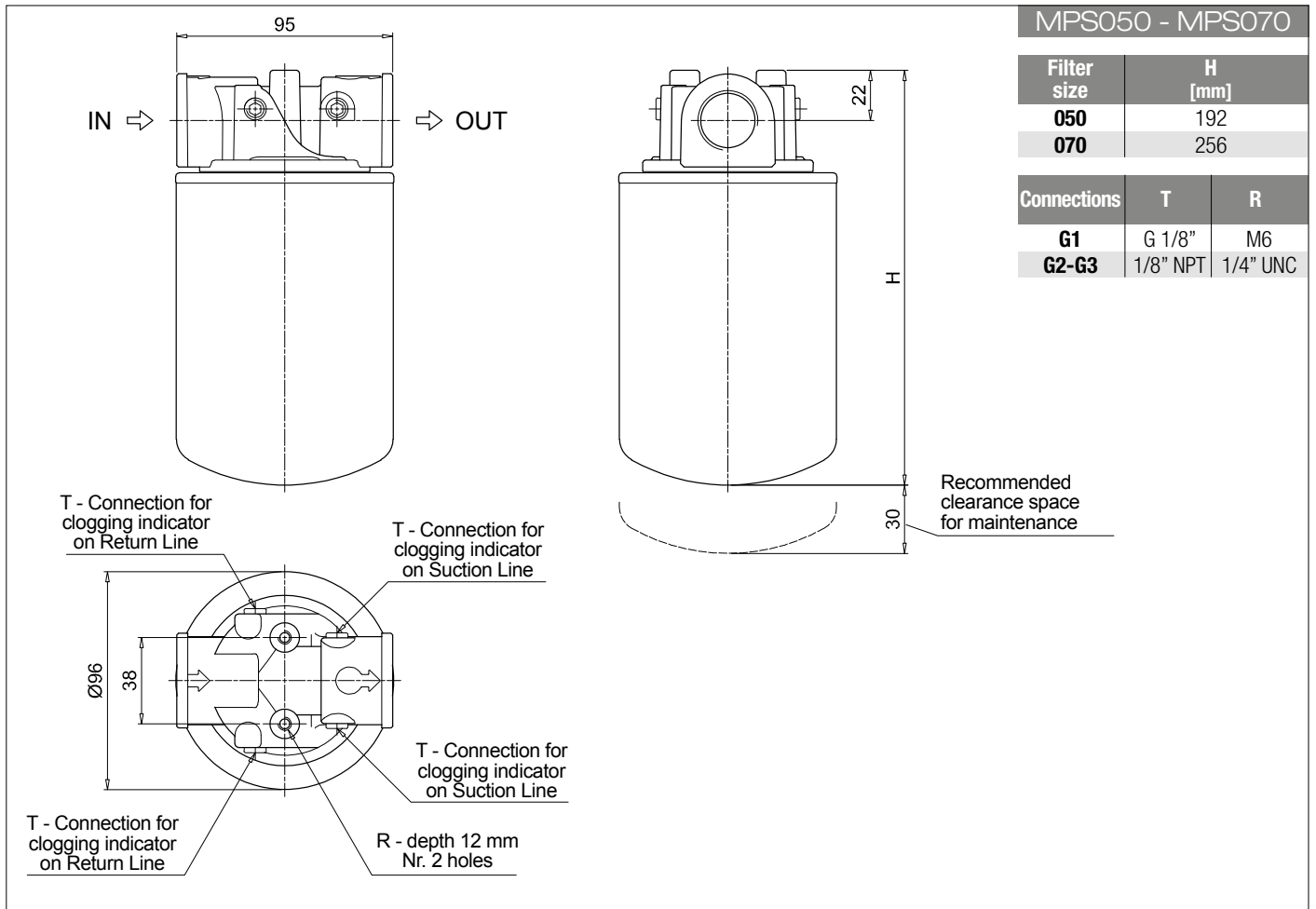

MPS MPS100 - MPS150 MPS101 - MPS151

Designation & Ordering code

COMPLETE FILTER

Series and size		Configuration example: MPS100 R G1 A10 A P01				
MPS100 MPS150	With connections for clogging indicators					
MPS101 MPS151	With connections for differential indicators					
Bypass valve		MPS 100 - 150	MPS 101 - 151			
R	Return: 1.75 bar	•	•			
S	Suction: 30 kPa	•				
U	Without bypass	•				
P	Without bypass		•			
Connections						
G1	G 1 1/4"					
G2	1 1/4" NPT					
G3	SAE 20 - 1 5/8" - 12 UN					
Filtration rating (filter media)						
A03	Inorganic microfiber 3 µm			M25	Wire mesh 25 µm	
A06	Inorganic microfiber 6 µm			M60	Wire mesh 60 µm	
A10	Inorganic microfiber 10 µm			M90	Wire mesh 90 µm	
A25	Inorganic microfiber 25 µm			P10	Resin impregnated paper 10 µm	
				P25	Resin impregnated paper 25 µm	
				Seal	A NBR	
				Execution	P01 MP Filtri standard	

CARTRIDGE

Cartridge series and size		Configuration example: CS100 A10 A P01			
CS100 CS150					
Filtration rating (filter media)					
A03	Inorganic microfiber 3 µm			M25	Wire mesh 25 µm
A06	Inorganic microfiber 6 µm			M60	Wire mesh 60 µm
A10	Inorganic microfiber 10 µm			M90	Wire mesh 90 µm
A25	Inorganic microfiber 25 µm			P10	Resin impregnated paper 10 µm
				P25	Resin impregnated paper 25 µm
				Seals	A NBR
				Execution	P01 MP Filtri standard Pxx Customized

ACCESSORIES

Clogging indicators on RETURN line		page			page
BVA	Axial pressure gauge	315	BEA	Electrical pressure indicator	314
BVR	Radial pressure gauge	315	BEM	Electrical pressure indicator	314
BVP	Visual pressure indicator with automatic reset	316	BLA	Electrical / visual pressure indicator	314-315
BVQ	Visual pressure indicator with manual reset	316			
Clogging indicators on SUCTION line		page			page
VVB	Axial pressure gauge	313	VEB	Electrical vacuum indicator	312
VVS	Radial pressure gauge	313	VLB	Electrical/visual vacuum indicator	312
Differential indicators		page			page
DEA	Electrical differential indicator	317	DTA	Electronic differential indicator	320
DEM	Electrical differential indicator	317-318	DVA	Visual differential indicator	320
DLA	Electrical / visual differential indicator	318-319	DVM	Visual differential indicator	320
DLE	Electrical / visual differential indicator	319			

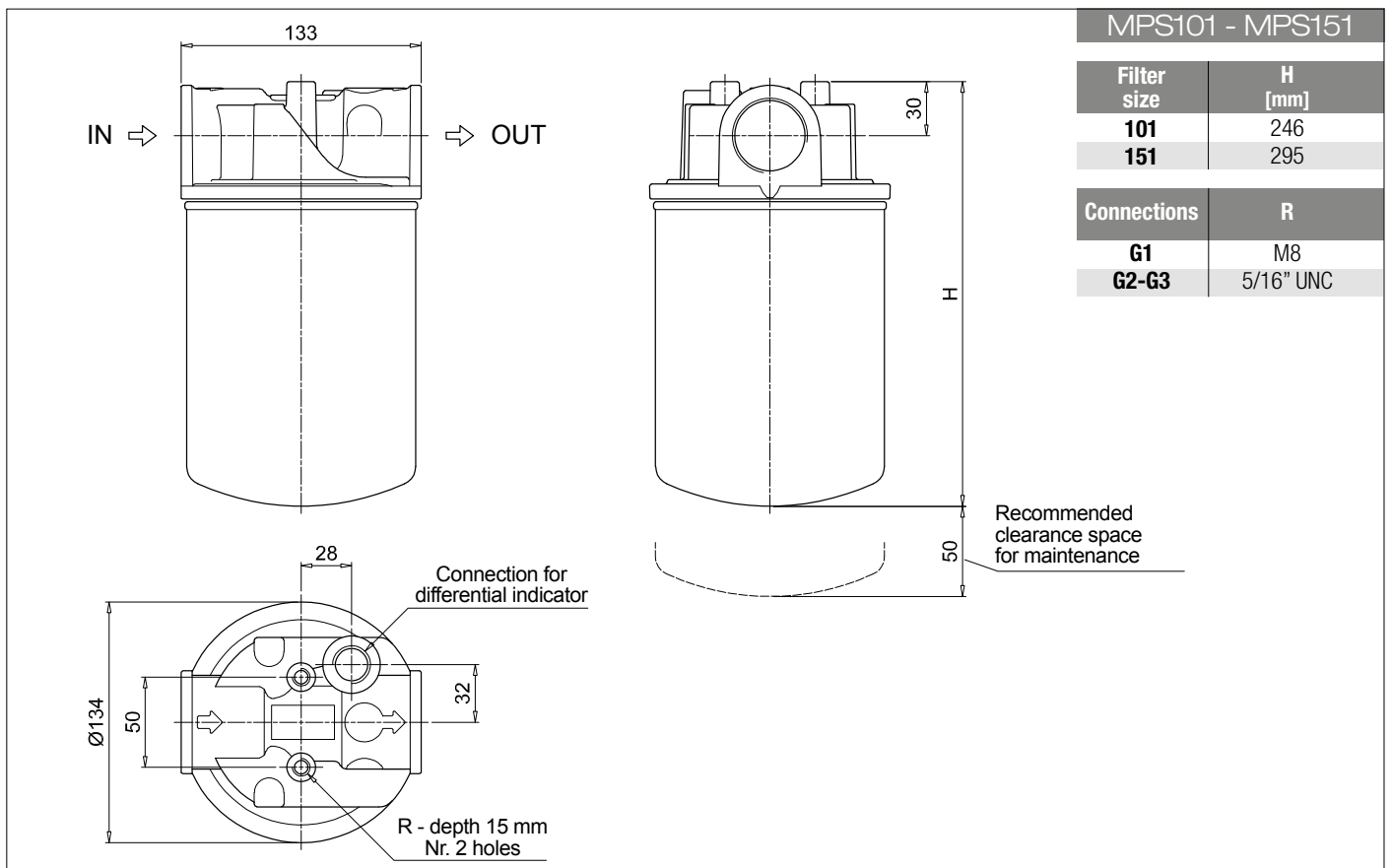
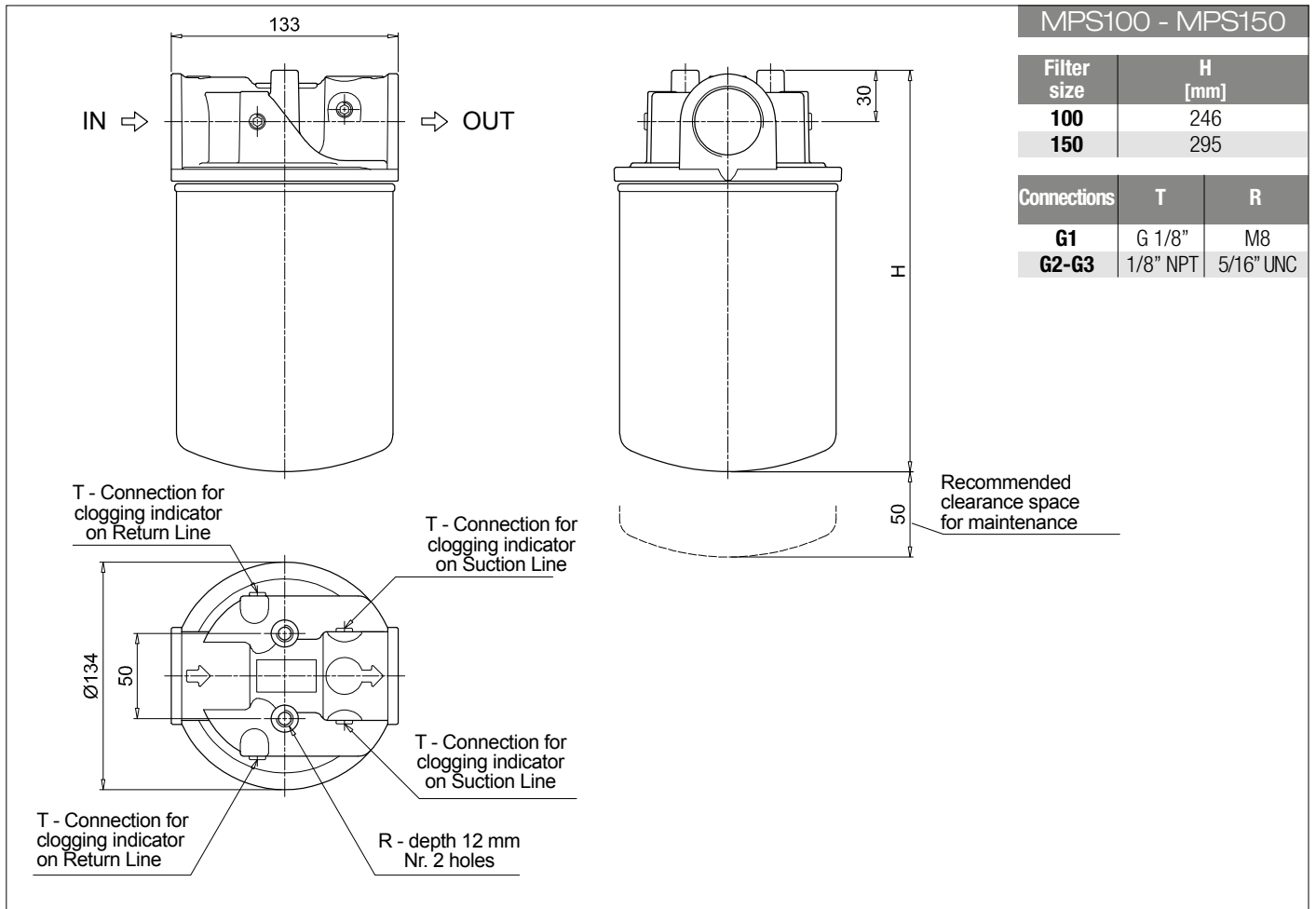

MPS MPS200 - MPS250

Designation & Ordering code

COMPLETE FILTER

Series and size

MPS200 | **MPS250**

Configuration example: **MPS200** **R** **G1** **A10** **A** **P01**

Bypass valve

R Return: 1.75 bar

S Suction: 30 kPa

U Without bypass

Connections

G1 G 1 1/2"

G2 1 1/2" NPT

G3 SAE 24 - 1 7/8" - 12 UN

Filtration rating (filter media)

A03 Inorganic microfiber 3 µm

A06 Inorganic microfiber 6 µm

A10 Inorganic microfiber 10 µm

A25 Inorganic microfiber 25 µm

M25 Wire mesh 25 µm

M60 Wire mesh 60 µm

M90 Wire mesh 90 µm

P10 Resin impregnated paper 10 µm

P25 Resin impregnated paper 25 µm

Seal

A NBR

Execution

P01 MP Filtri standard

CARTRIDGE

Cartridge series and size

CS100 | **CS150**

Configuration example: **CS100** **A10** **A** **P01**

Filtration rating (filter media)

A03 Inorganic microfiber 3 µm

A06 Inorganic microfiber 6 µm

A10 Inorganic microfiber 10 µm

A25 Inorganic microfiber 25 µm

M25 Wire mesh 25 µm

M60 Wire mesh 60 µm

M90 Wire mesh 90 µm

P10 Resin impregnated paper 10 µm

P25 Resin impregnated paper 25 µm

Seals

A NBR

Execution

P01 MP Filtri standard

Pxx Customized

ACCESSORIES

Clogging indicators on RETURN line

BVA Axial pressure gauge 315

BVR Radial pressure gauge 315

BVP Visual pressure indicator with automatic reset 316

BVQ Visual pressure indicator with manual reset 316

BEA Electrical pressure indicator 314

BEM Electrical pressure indicator 314

BLA Electrical / visual pressure indicator 314-315

Clogging indicators on SUCTION line

VVB Axial pressure gauge 313

VVS Radial pressure gauge 313

VEB Electrical vacuum indicator 312

VLB Electrical/visual vacuum indicator 312

MPS200 - MPS250

Filter size	H [mm]
200	213
250	262

Connections	T	R
G1	G 1/8"	M10
G2-G3	1/8" NPT	7/16" UNC

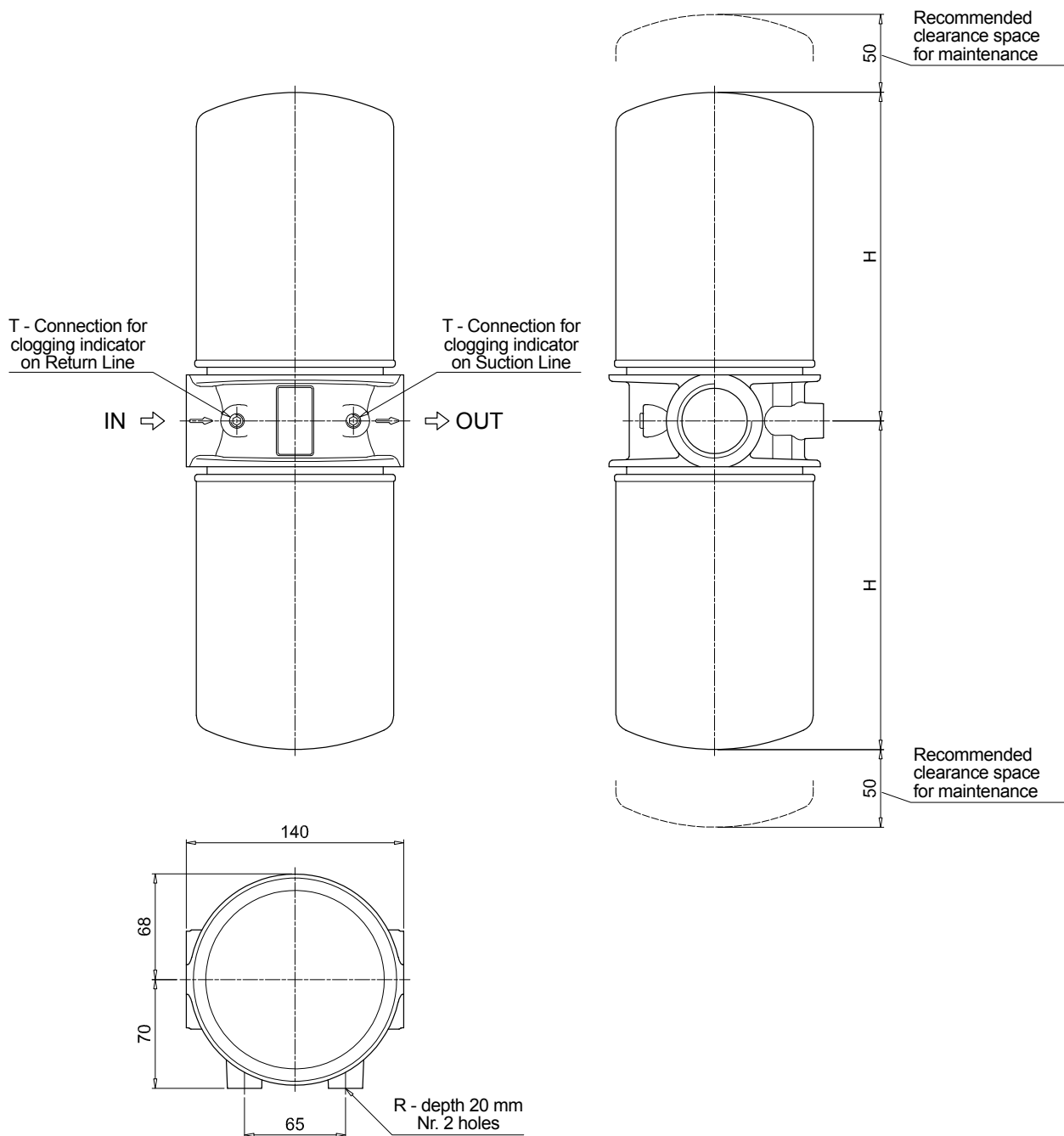

MPS MPS300 - MPS350 MPS301 - MPS351

Designation & Ordering code

COMPLETE FILTER

Series and size		Configuration example: MPS300 R F1 A10 A P01				
MPS300 MPS350	With connections for clogging indicators					
MPS301 MPS351	With connections for differential indicators					
Bypass valve		MPS 300 - 350	MPS 301 - 351			
R	Return: 1.75 bar	•	•			
S	Suction: 30 kPa	•				
U	Without bypass	•				
P	Without bypass		•			
Connections						
G1	G 1 1/2"					
G2	1 1/2" NPT					
G3	SAE 24 - 1 7/8" - 12 UN					
F1	1 1/2" SAE 3000 psi/M					
F2	1 1/2" SAE 3000 psi/UNC					
Filtration rating (filter media)						
A03	Inorganic microfiber 3 µm	M25	Wire mesh 25 µm			
A06	Inorganic microfiber 6 µm	M60	Wire mesh 60 µm			
A10	Inorganic microfiber 10 µm	M90	Wire mesh 90 µm			
A25	Inorganic microfiber 25 µm	P10	Resin impregnated paper 10 µm			
		P25	Resin impregnated paper 25 µm			
		Seals		Execution		
		A NBR		P01 MP Filtri standard		

CARTRIDGE

Cartridge series and size		Configuration example: CS100 A10 A P01			
CS100 CS150					
Filtration rating (filter media)					
A03	Inorganic microfiber 3 µm	M25	Wire mesh 25 µm		
A06	Inorganic microfiber 6 µm	M60	Wire mesh 60 µm		
A10	Inorganic microfiber 10 µm	M90	Wire mesh 90 µm		
A25	Inorganic microfiber 25 µm	P10	Resin impregnated paper 10 µm		
		P25	Resin impregnated paper 25 µm		
		Seals		Execution	
		A NBR		P01 MP Filtri standard	
				Pxx Customized	

ACCESSORIES

Clogging indicators on RETURN line			Clogging indicators on SUCTION line		
	page			page	
BVA	Axial pressure gauge	315	BEA	Electrical pressure indicator	314
BVR	Radial pressure gauge	315	BEM	Electrical pressure indicator	314
BVP	Visual pressure indicator with automatic reset	316	BLA	Electrical / visual pressure indicator	314-315
BVQ	Visual pressure indicator with manual reset	316			
VVB	Axial pressure gauge	313	VEB	Electrical vacuum indicator	312
VVS	Radial pressure gauge	313	VLB	Electrical/visual vacuum indicator	312
Differential indicators			Differential indicators		
DEA	Electrical differential indicator	317	DTA	Electronic differential indicator	320
DEM	Electrical differential indicator	317-318	DVA	Visual differential indicator	320
DLA	Electrical / visual differential indicator	318-319	DVM	Visual differential indicator	320
DLE	Electrical / visual differential indicator	319			

MPS300 - MPS350

Filter size	H [mm]
300	266
350	315

Connections	T	R
G1	G 1/8"	M10
G2-G3	1/8" NPT	7/16" UNC
F1	G 1/8"	M10
F2	1/8" NPT	7/16" UNC

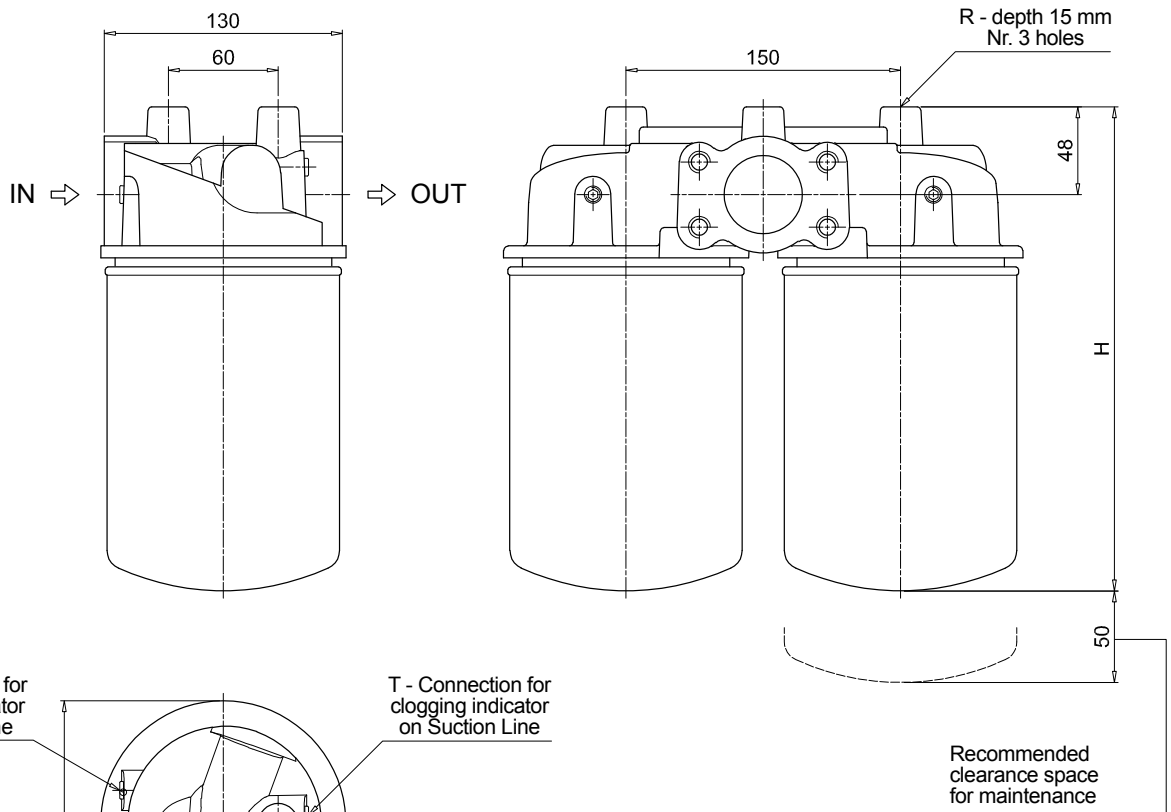

MPS MPS300 - MPS350 MPS301 - MPS351

Dimensions

MPS301 - MPS351

Filter size	H [mm]
301	266
351	315

Connections	R
G1	M10
G2-G3	7/16" UNC
F1	M10
F2	7/16" UNC

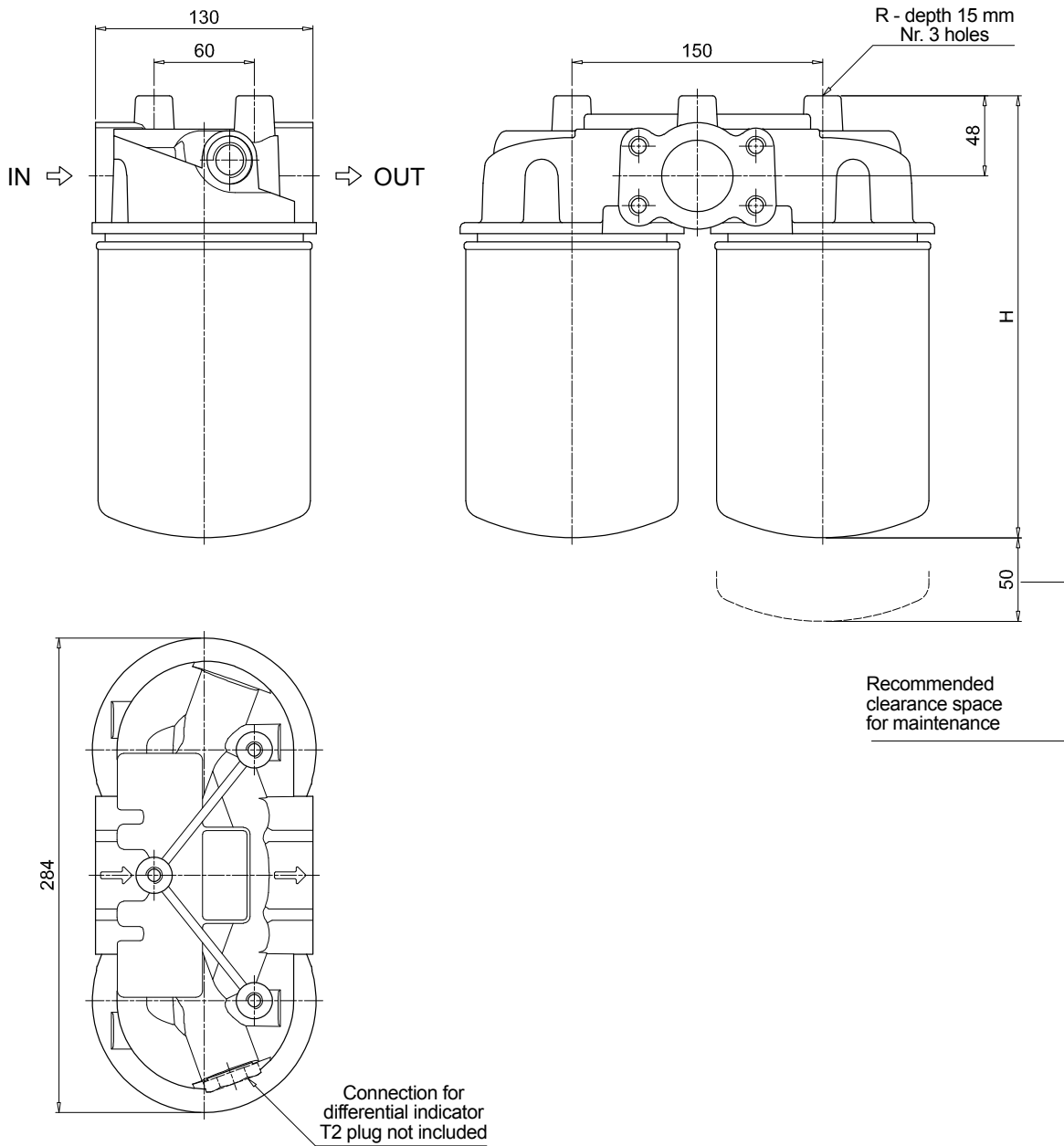

MSH series

Maximum working pressure up to 3.5 MPa (35 bar) - Flow rate up to 195 l/min



Description

Technical data

Spin-on filters

Maximum working pressure up to 3.5 MPa (35 bar)
Flow rate up to 195 l/min

MSH is a range of spin-on filters suitable to be used in low pressure lines. They offer a good balance between performances, dimensions and prices. They are directly connected to the lines of the system through the hydraulic fittings.

Available features:

- Female threaded connections up to 1 1/4", for a maximum flow rate of 195 l/min
- Fine filtration rating, to get a good cleanliness level into the reservoir
- Strong sealing between the housing and cans, to be used in heavy applications
- Bypass valve, to relieve excessive pressure drop across the filter media
- Visual, electrical and electronic differential clogging indicators for low pressure applications

Common applications:

- Delivery lines, in economic industrial equipment or mobile machines

Filter housing materials

- Head: Anodized Aluminium
- Bypass valve: Nylon - Steel
- Element: Aluminium - Painted Steel

Bypass valve

Opening pressure: 250 kPa (2.5 bar) ±10%

Δp element type

- Δp: 5 bar
- Oil flow from OUT to IN

Seals

- Standard NBR - series A
- Optional FPM - series V

Temperature

From -20 °C to +110 °C

Note

MSH filters are provided for vertical mounting



Weights [kg] and volumes [dm³]

Filter series	Weights [kg]	Volumes [dm ³]
MSH 050	1.50	0.65
MSH 070	1.90	0.95
MSH 100	3.30	1.80
MSH 150	3.80	2.20

Cartridge

Thread connections	
Type	Connection
CH 050 - 070	M32 x 2
CH 100 - 150	M45 x 2

CH

Filter series	Style S	Style B
MSH 050	•	•
MSH 070	•	•
MSH 100	•	•
MSH 150	•	•

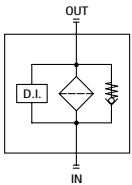
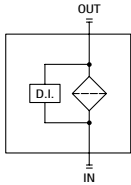

Pressure drop

Bypass valve pressure drop

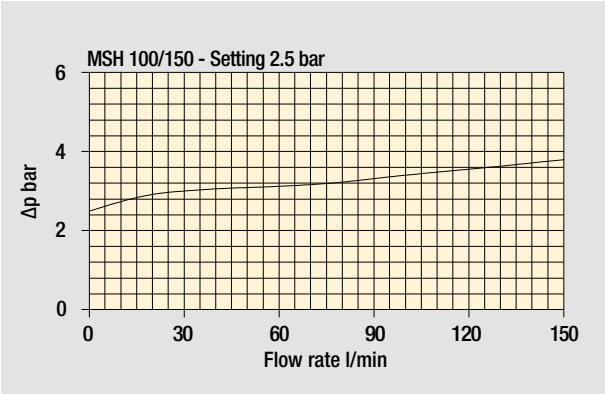
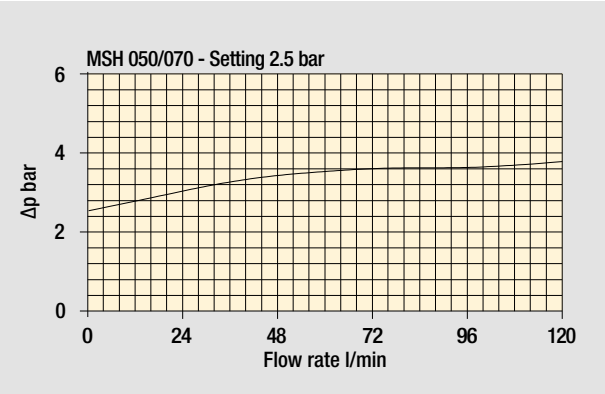

The curves are plotted using mineral oil with density of 0.86 kg/dm³ in compliance with ISO 3968. Δp varies proportionally with density.

MSH MSH050 - MSH070 MSH100 - MSH150

Designation & Ordering code

COMPLETE FILTER

Series and size		Configuration example: MSH050 B A G1 A10 P01				
MSH050 MSH070 MSH100 MSH150						
Bypass valve						
S	Without bypass					
B	2.5 bar					
Seal						
A	NBR					
Connections	MSH 050 - 070	MSH 100 - 150				
G1	G 1"	G 1 1/2"				
G2	G 3/4"	G 1 1/4"				
G3	1" NPT	1 1/2" NPT				
G4	3/4" NPT	1 1/4" NPT				
G5	SAE 16 - 1 5/16" - 12 UN	SAE 24 - 1 7/8" - 12 UN				
G6	SAE 12 - 1 1/16" - 12 UN	SAE 20 - 1 5/8" - 12 UN				
Filtration rating (filter media)						
A03	Inorganic microfiber 3 µm	M25	Wire mesh 25 µm			
A06	Inorganic microfiber 6 µm	M60	Wire mesh 60 µm			
A10	Inorganic microfiber 10 µm	M90	Wire mesh 90 µm			
A25	Inorganic microfiber 25 µm	P10	Resin impregnated paper 10 µm			
		P25	Resin impregnated paper 25 µm			
		Execution				
		P01 MP Filtri standard				

CARTRIDGE

Cartridge series and size		Configuration example: CH050 A10 A P01			
CH050 CH070 CH100 CH150					
Filtration rating (filter media)					
A03	Inorganic microfiber 3 µm	M25	Wire mesh 25 µm		
A06	Inorganic microfiber 6 µm	M60	Wire mesh 60 µm		
A10	Inorganic microfiber 10 µm	M90	Wire mesh 90 µm		
A25	Inorganic microfiber 25 µm	P10	Resin impregnated paper 10 µm		
		P25	Resin impregnated paper 25 µm		
		Seal		Execution	
		A NBR		P01 MP Filtri standard	
				Pxx Customized	

ACCESSORIES

Differential indicators	page		page
DEA Electrical differential indicator	317	DTA Electronic differential indicator	320
DEM Electrical differential indicator	317-318	DVA Visual differential indicator	320
DLA Electrical / visual differential indicator	318-319	DVM Visual differential indicator	320
DLE Electrical / visual differential indicator	319		

Additional features	page
T2 Plug	321

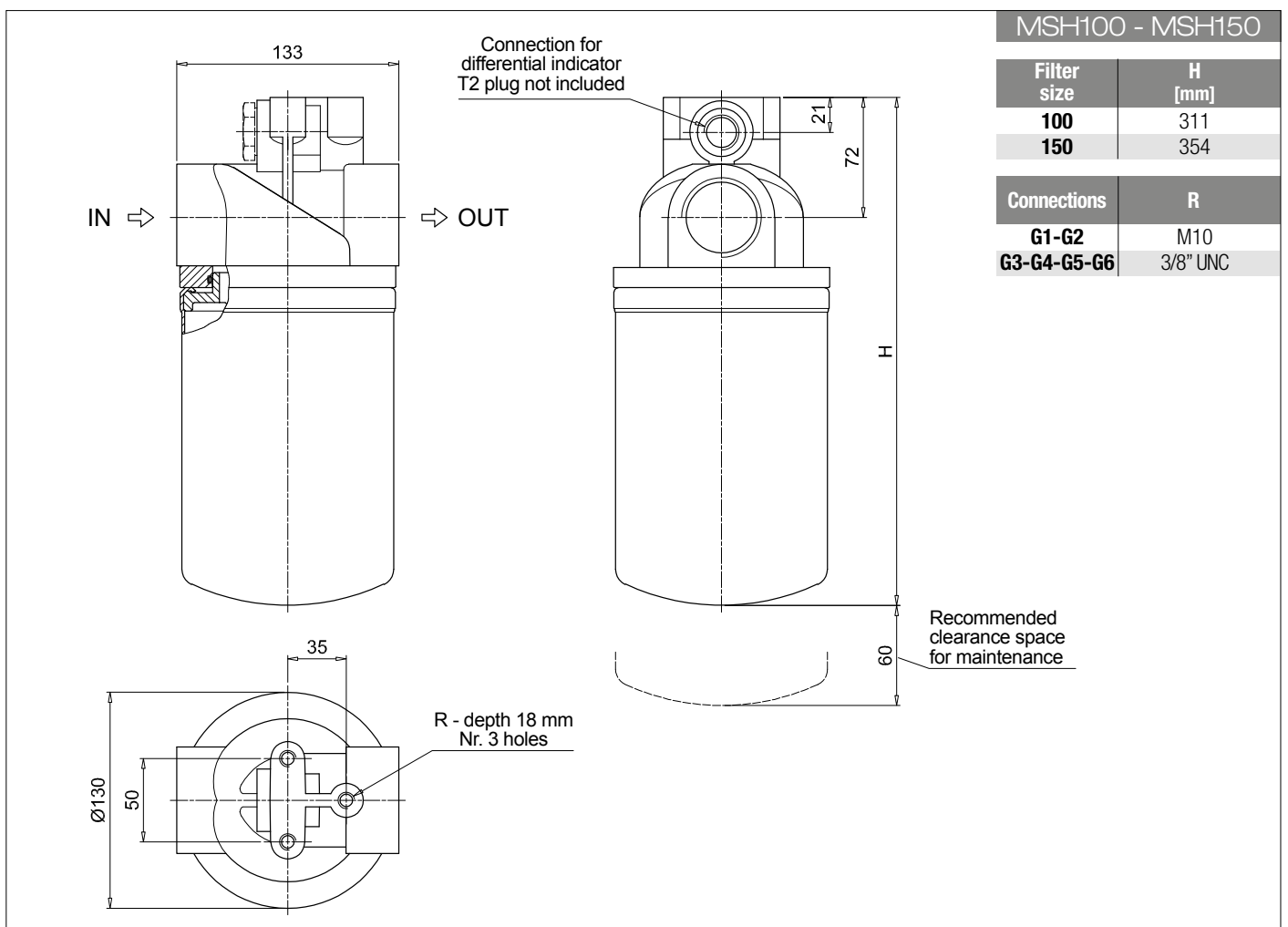
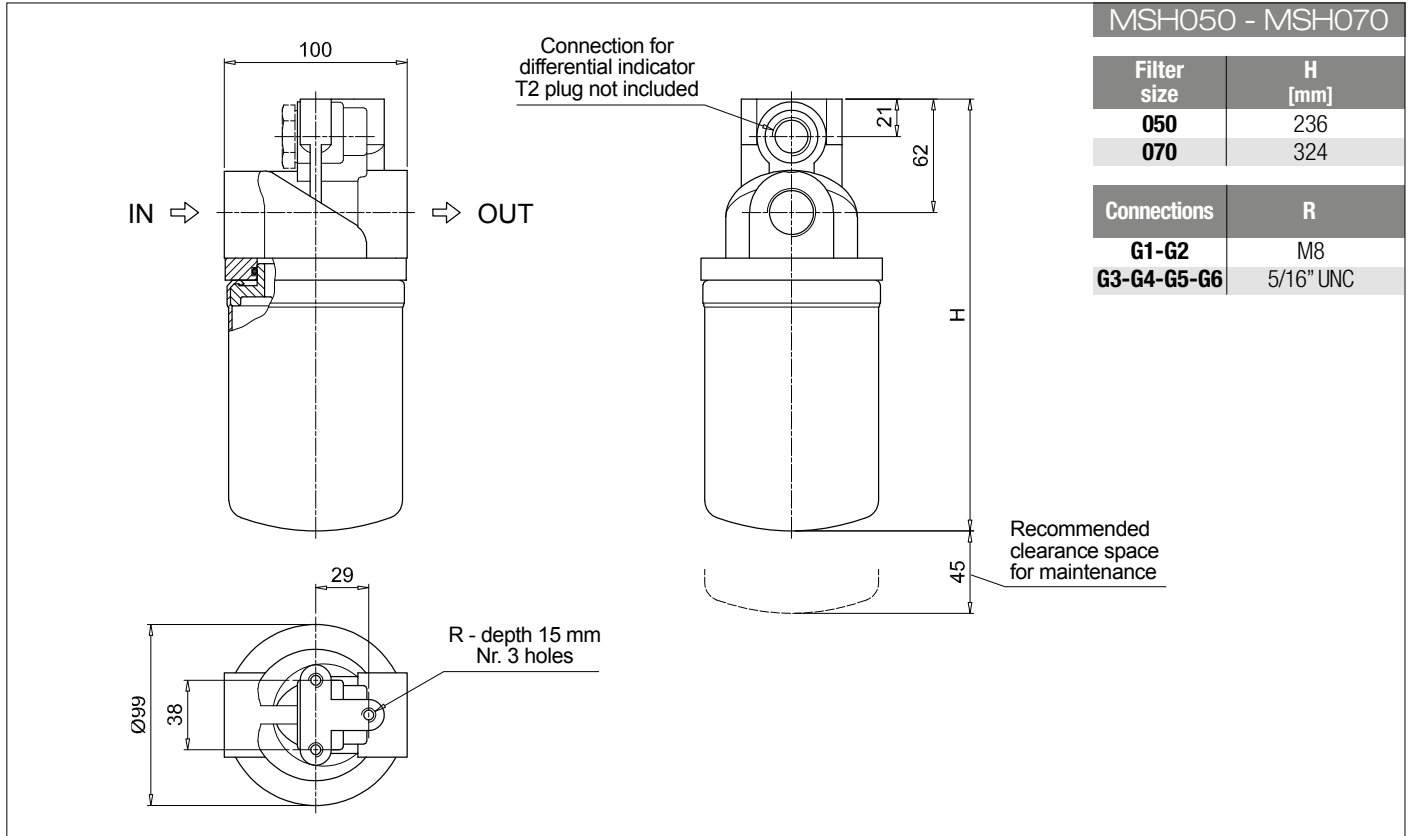

MSH SPARE PARTS

Order number for spare parts

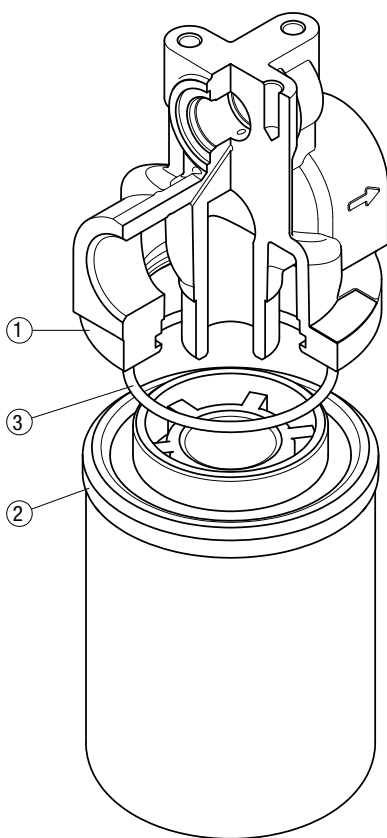

Item:	Q.ty: 1 pc. 1	Q.ty: 1 pc. 2	Q.ty: 1 pc. 3
Filter series	Filter assembly	Cartridge	Seal code number
MSH 050-070	See order table	See order table	0-R 167 (ø 63.50 x 3.53)
MSH 100-150	See order table	See order table	0-R 4362 (ø 91.67 x 3.53)

Clogging indicators

Introduction

Filter elements are efficient only if their Dirt Holding Capacity is fully exploited. This is achieved by using filter housings equipped with clogging indicators. These devices trip when the clogging of the filter element causes an increase in pressure drop across the filter element.

The indicator is set to alarm before the element becomes fully clogged.

MP Filtri can supply indicators of the following designs:

- Vacuum switches and gauges
- Pressure switches and gauges
- Differential pressure indicators

These type of devices can be provided with a visual, electrical or both signals.

Barometric indicators
Vacuum indicators
Differential indicators

Suitable indicator types

VACUUM INDICATORS

Vacuum indicators are used on the Suction line to check the efficiency of the filter element.

They measure the pressure downstream of the filter element. Standard items are produced with R 1/4" EN 10226 connection. Available products with R 1/8" EN 10226 to be fitted on MPS series.

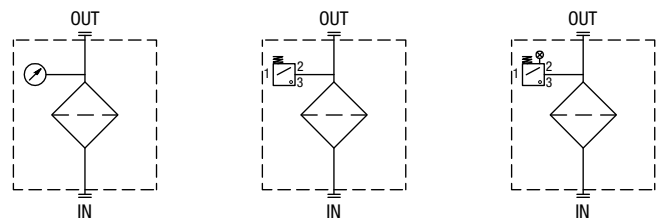

BAROMETRIC INDICATORS

Pressure indicators are used on the Return line to check the efficiency of the filter element.

They measure the pressure upstream of the filter element. Standard items are produced with R 1/8" EN 10226 connection.

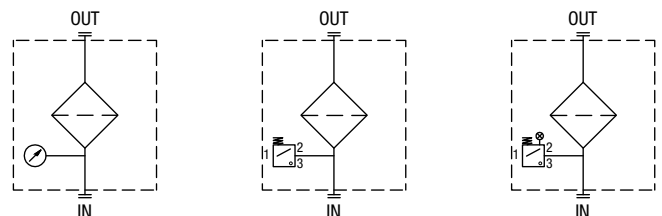

DIFFERENTIAL INDICATORS

Differential indicators are used on the Pressure line to check the efficiency of the filter element.

They measure the pressure upstream and downstream of the filter element (differential pressure). Standard items are produced with special connection G 1/2" size. Also available in Stainless Steel models.

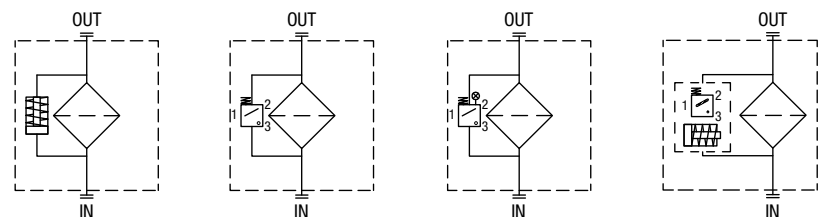

Quick reference guide

	Filter series	Visual indicator	Electrical indicator	Electrical / Visual indicator
Suction line	MPS 050 - 070 - 100 - 150 MPS 200 - 250 - 300 - 350	VVB16P01 VVS16P01	VEB21AA50P01	VLB21AA51P01 VLB21AA52P01 VLB21AA53P01 VLB21AA71P01
Return line	MPS 050 - 070 - 100 - 150 MPS 200 - 250 - 300 - 350	BVA14P01 BVR14P01 BVP20HP01 BVQ20HP01	BEA15HA50P01 BEM15HA41P01	BLA15HA51P01 BLA15HA52P01 BLA15HA53P01 BLA15HA71P01
In-line	MPS 051 - 071 - 101 - 151 MPS 301 - 351 MSH 050 - 070 - 100 - 150	DVA12xP01 DVM12xP01	DEA12xA50P01 DEM12xAxxP01	DLA12xA51P01 DLA12xA52P01 DLA12xA71P01 DLE12xA50P01 DLE12xF50P01

VACUUM INDICATORS

Dimensions

VE*50	
Electrical Vacuum Indicator	
R	Ordering code
EN 10226 - R1/8"	VE B 21 A A 50 P01
<p>Hydraulic symbol</p>	
<p>Electrical symbol</p>	
<p>Materials</p> <ul style="list-style-type: none"> - Body: Brass - Base: Black Nylon - Contacts: Silver - Seal: NBR 	
<p>Technical data</p> <ul style="list-style-type: none"> - Vacuum setting: -0.21 bar ±10% - Max working pressure: 10 bar - Proof pressure: 15 bar - Working temperature: From -25 °C to +80 °C - Compatibility with fluids: Mineral oils, Synthetic fluids HFA, HFB, HFC according to ISO 2943 - Degree of protection: IP65 according to EN 60529 	
<p>Electrical data</p> <ul style="list-style-type: none"> - Electrical connection: EN 175301-803 - Resistive load: 5 A / 14 Vdc 4 A / 30 Vdc 5 A / 125 Vac 4 A / 250 Vac - Available Atex product: II 1GD Ex ia IIC Tx Ex ia IIIC Tx°C X - CE certification 	

VL*51 - VL*52 - VL*53	
Electrical/Visual Vacuum Indicator	
R	Ordering code
EN 10226 - R1/8"	VL B 21 A A xx P01
<p>Hydraulic symbol</p>	
<p>Electrical symbol</p>	
<p>Materials</p> <ul style="list-style-type: none"> - Body: Brass - Base: Transparent Nylon - Contacts: Brass - Nylon - Seal: NBR 	
<p>Technical data</p> <ul style="list-style-type: none"> - Vacuum setting: -0.21 bar ±10% - Max working pressure: 10 bar - Proof pressure: 15 bar - Working temperature: From -25 °C to +80 °C - Compatibility with fluids: Mineral oils, Synthetic fluids HFA, HFB, HFC according to ISO 2943 - Degree of protection: IP65 according to EN 60529 	
<p>Electrical data</p> <ul style="list-style-type: none"> - Electrical connection: EN 175301-803 - Type: 51 52 53 - Lamps: 24 Vdc 110 Vdc 230 Vac - Resistive load: 1 A / 24 Vdc 1 A / 110 Vdc 1 A / 230 Vac 	

VL*71	
Electrical/Visual Vacuum Indicator	
Connections	Ordering code
EN 10226 - R1/8"	VL B 21 A A 71 P01
<p>Hydraulic symbol</p>	
<p>Electrical symbol</p>	
<p>Materials</p> <ul style="list-style-type: none"> - Body: Brass - Base: Black Nylon - Contacts: Silver - Seal: NBR 	
<p>Technical data</p> <ul style="list-style-type: none"> - Vacuum setting: -0.21 bar ±10% - Max working pressure: 10 bar - Proof pressure: 15 bar - Working temperature: From -25 °C to +80 °C - Compatibility with fluids: Mineral oils, Synthetic fluids HFA, HFB, HFC according to ISO 2943 - Degree of protection: IP65 according to EN 60529 	
<p>Electrical data</p> <ul style="list-style-type: none"> - Electrical connection: IEC 61076-2-101 D (M12) - Lamps: 24 Vdc - Resistive load: 0.4 A / 24 Vdc 	

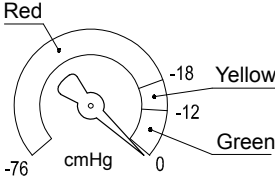
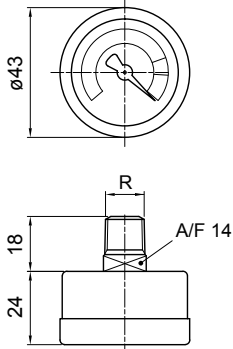
VVB		Hydraulic symbol	Materials								
Axial Vacuum Gauge					<ul style="list-style-type: none"> - Case: Painted Steel - Window: Transparent plastic - Dial: Painted Steel - Pointer: Painted Aluminium - Pressure connection: Brass - Pressure element: Bourdon tube Cu-alloy soft soldered 						
R	Ordering code										
EN 10226 - R1/8"	VV B 16 P01	Dial scale 									
			Technical data <ul style="list-style-type: none"> - Max working pressure: Static: 7 bar Fluctuating: 6 bar Short time: 10 bar - Working temperature: From -40 °C to +60 °C - Compatibility with fluids: Mineral oils, Synthetic fluids HFA, HFB, HFC according to ISO 2943 - Accuracy: Class 2.5 according to EN 13190 - Degree of protection: IP31 according to EN 60529 								
		Conversion to SI units <table border="1"> <thead> <tr> <th>[cmHg]</th> <th>[bar]</th> </tr> </thead> <tbody> <tr> <td>-12</td> <td>-0.16</td> </tr> <tr> <td>-18</td> <td>-0.24</td> </tr> <tr> <td>-76</td> <td>-1.01</td> </tr> </tbody> </table>	[cmHg]	[bar]	-12	-0.16	-18	-0.24	-76	-1.01	
[cmHg]	[bar]										
-12	-0.16										
-18	-0.24										
-76	-1.01										

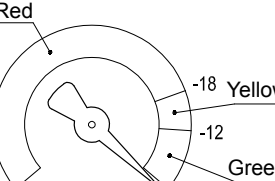
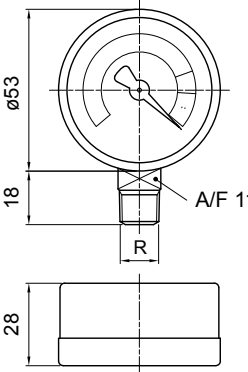
VVS		Hydraulic symbol	Materials								
Radial Vacuum Gauge					<ul style="list-style-type: none"> - Case: Painted Steel - Window: Transparent plastic - Dial: Painted Steel - Pointer: Painted Aluminium - Pressure connection: Brass - Pressure element: Bourdon tube Cu-alloy soft soldered 						
R	Ordering code										
EN 10226 - R1/8"	VV S 16 P01	Dial scale 									
			Technical data <ul style="list-style-type: none"> - Max working pressure: Static: 7 bar Fluctuating: 6 bar Short time: 10 bar - Working temperature: From -40 °C to +60 °C - Compatibility with fluids: Mineral oils, Synthetic fluids HFA, HFB, HFC according to ISO 2943 - Accuracy: Class 2.5 according to EN 13190 - Degree of protection: IP31 according to EN 60529 								
		Conversion to SI units <table border="1"> <thead> <tr> <th>[cmHg]</th> <th>[bar]</th> </tr> </thead> <tbody> <tr> <td>-12</td> <td>-0.16</td> </tr> <tr> <td>-18</td> <td>-0.24</td> </tr> <tr> <td>-76</td> <td>-1.01</td> </tr> </tbody> </table>	[cmHg]	[bar]	-12	-0.16	-18	-0.24	-76	-1.01	
[cmHg]	[bar]										
-12	-0.16										
-18	-0.24										
-76	-1.01										

DESIGNATION & ORDERING CODE									
Series		Configuration example 1:	VE	B	21	A	A	50	P01
VE	Electrical vacuum indicator	Configuration example 2:	VL	B	21	A	A	71	P01
VL	Electrical/Visual vacuum indicator	Configuration example 3:	VV	S	16				P01
VV	Vacuum gauge								
Type VE - VL		Type VV							
B	Connection EN 10226 - R1/8"	B	Axial connection EN 10226 - R1/8"						
		S	Radial connection EN 10226 - R1/8"						
Vacuum setting		VE	VL	VV					
16	-0.16 bar			•					
21	-0.21 bar	•	•						
Seals		VE	VL	VV					
A	NBR	•	•						
Thermostat		VE	VL	VV					
A	Without	•	•						
Electrical connections		VE	VL	VV					
50	Connection EN 175301-803	•							
51	Connection EN 175301-803, transparent base with lamps 24 Vdc		•						
52	Connection EN 175301-803, transparent base with lamps 110 Vdc		•						
53	Connection EN 175301-803, transparent base with lamps 230 Vdc		•						
71	Connection IEC 61076-2-101 D (M12), black base with lamps 24 Vdc		•						
									Option
									P01 MP Filtri standard
									Pxx Customized

BAROMETRIC INDICATORS

Dimensions

BEA*50		
Electrical Pressure Indicator		
Settings	Ordering code	
1.5 bar ±10%	BE A 15 H A 50 P01	
2.0 bar ±10%	BE A 20 H A 50 P01	
<p>Hydraulic symbol</p>		<p>Materials</p> <ul style="list-style-type: none"> - Body: Brass - Base: Black Nylon - Contacts: Silver - Seal: HNBR <p>Technical data</p> <ul style="list-style-type: none"> - Max working pressure: 40 bar - Proof pressure: 60 bar - Working temperature: From -25 °C to +80 °C - Compatibility with fluids: Mineral oils, Synthetic fluids HFA, HFB, HFC according to ISO 2943 - Degree of protection: IP65 according to EN 60529 <p>Electrical data</p> <ul style="list-style-type: none"> - Electrical connection: EN 175301-803 - Resistive load: 5 A / 14 Vdc 4 A / 30 Vdc 5 A / 125 Vac 4 A / 250 Vac <ul style="list-style-type: none"> - Available Atex product: II 1GD Ex ia IIC Tx Ex ia IIIC Tx°C X - CE certification

BEM*41		
Electrical Pressure Indicator		
Settings	Ordering code	
1.5 bar ±10%	BE M 15 H A 41 P01	
2.0 bar ±10%	BE M 20 H A 41 P01	
<p>Hydraulic symbol</p>		<p>Materials</p> <ul style="list-style-type: none"> - Body: Brass - Base: Black Nylon - Contacts: Silver - Seal: HNBR <p>Technical data</p> <ul style="list-style-type: none"> - Max working pressure: 40 bar - Proof pressure: 60 bar - Working temperature: From -25 °C to +80 °C - Compatibility with fluids: Mineral oils, Synthetic fluids HFA, HFB, HFC according to ISO 2943 - Degree of protection: IP67 according to EN 60529 <p>Electrical data</p> <ul style="list-style-type: none"> - Electrical connection: Four-core cable - Resistive load: 5 A / 14 Vdc 4 A / 30 Vdc 5 A / 125 Vac 4 A / 250 Vac <ul style="list-style-type: none"> - CE certification On request this indicator can be provided with main connectors in use for wirings.

BL*51 - BL*52 - BL*53		
Electrical/Visual Pressure Indicator		
Settings	Ordering code	
1.5 bar ±10%	BL A 15 H A xx P01	
2.0 bar ±10%	BL A 20 H A xx P01	
<p>Hydraulic symbol</p>		<p>Materials</p> <ul style="list-style-type: none"> - Body: Brass - Base: Transparent Nylon - Contacts: Silver - Seal: HNBR <p>Technical data</p> <ul style="list-style-type: none"> - Max working pressure: 40 bar - Proof pressure: 60 bar - Working temperature: From -25 °C to +80 °C - Compatibility with fluids: Mineral oils, Synthetic fluids HFA, HFB, HFC according to ISO 2943 - Degree of protection: IP65 according to EN 60529 <p>Electrical data</p> <ul style="list-style-type: none"> - Electrical connection: EN 175301-803 - Type: 51 52 53 - Lamps: 24 Vdc 110 Vdc 230 Vac - Resistive load: 1 A / 24 Vdc 1 A / 110 Vdc 1 A / 230 Vac

BL*71	
Electrical/Visual Pressure Indicator	
Settings	Ordering code
1.5 bar ±10%	BL A 15 HA 71 P01
2.0 bar ±10%	BL A 20 HA 71 P01

Hydraulic symbol

Electrical symbol

Materials

- Body: Brass
- Base: Black Nylon
- Contacts: Silver
- Seal: HNBR

Technical data

- Max working pressure: 40 bar
- Proof pressure: 60 bar
- Working temperature: From -25 °C to +80 °C
- Compatibility with fluids: Mineral oils, Synthetic fluids HFA, HFB, HFC according to ISO 2943
- Degree of protection: IP65 according to EN 60529

Electrical data

- Electrical connection: IEC 61076-2-101 D (M12)
- Lamps: 24 Vdc
- Resistive load: 0.4 A / 24 Vdc

BVA	
Axial Pressure Gauge	
Settings	Ordering code
1.4 bar ±10%	BV A 14 P01
2.5 bar ±10%	BV A 25 P01

Hydraulic symbol

Dial scale

BV A 14 P01

BV A 25 P01

Materials

- Case: Painted Steel
- Window: Transparent plastic
- Dial: Painted Steel
- Pointer: Painted Aluminium
- Pressure connection: Brass
- Pressure element: Bourdon tube Cu-alloy soft soldered

Technical data

- Max working pressure: Static: 7 bar
Fluctuating: 6 bar
Short time: 10 bar
- Working temperature: From -40 °C to +60 °C
- Compatibility with fluids: Mineral oils, Synthetic fluids HFA, HFB, HFC according to ISO 2943
- Accuracy: Class 2.5 according to EN 13190
- Degree of protection: IP31 according to EN 60529

BVR	
Radial Pressure Gauge	
Settings	Ordering code
1.4 bar ±10%	BV R 14 P01
2.5 bar ±10%	BV R 25 P01

Hydraulic symbol

Dial scale

BV R 14 P01

BV R 25 P01

Materials

- Case: Painted Steel
- Window: Transparent plastic
- Dial: Painted Steel
- Pointer: Painted Aluminium
- Pressure connection: Brass
- Pressure element: Bourdon tube Cu-alloy soft soldered

Technical data

- Max working pressure: Static: 7 bar
Fluctuating: 6 bar
Short time: 10 bar
- Working temperature: From -40 °C to +60 °C
- Compatibility with fluids: Mineral oils, Synthetic fluids HFA, HFB, HFC according to ISO 2943
- Accuracy: Class 2.5 according to EN 13190
- Degree of protection: IP31 according to EN 60529

BAROMETRIC INDICATORS

Dimensions

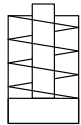
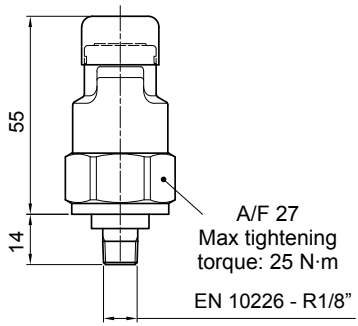
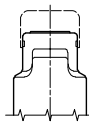
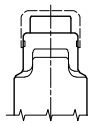
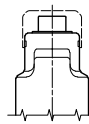
BVP - BVQ		Hydraulic symbol	Materials	
Visual Pressure Indicator				
Setting	Ordering code			
1.5 bar ±10%	BV P 15 H P01		Technical data - Reset: BVP - Automatic reset BVQ - Manual reset - Max working pressure: 10 bar - Proof pressure: 15 bar - Working temperature: From -25 °C to +80 °C - Compatibility with fluids: Mineral oils, Synthetic fluids HFA, HFB, HFC according to ISO 2943 - Degree of protection: IP45 according to EN 60529	
	BV Q 15 H P01			
2.0 bar ±10%	BV P 20 H P01			
	BV Q 20 H P01			
		Signals		
		 Absence of pressure (no indicator)	 Presence of pressure (green button rises gradually)	 Clogged filter element (red button risen)

DESIGNATION & ORDERING CODE

Series
BE Electrical pressure indicator
BL Electrical/Visual pressure indicator
BV Visual pressure indicator

Configuration example 1:	BE	M	15	H	A	41	P01
Configuration example 2:	BL	A	20	H	A	71	P01
Configuration example 3:	BV	R	14				P01
Configuration example 4:	BV	P	20	H			P01

Type	BE	BL	BV
A Standard type	•	•	A Axial connection pressure gauge
M With wired electrical connection	•		R Radial connection pressure gauge
			P Visual indicator with automatic reset
			Q Visual indicator with manual reset

Pressure setting	BEA-BEM	BLA	BVA-BVR	BVP-BVQ
14 1.4 bar			•	
15 1.5 bar	•	•		
20 2 bar	•	•		•
25 2.5 bar			•	

Seals	BE	BLA	BVA-BVR	BVP-BVQ
H HNBR	•	•		•

Thermostat	BEA-BEM	BLA	BV
A Without	•	•	

Electrical connections	BEA	BEM	BL	BV
10 Connection AMP Superseal series 1.5				
30 Connection Deutsch DT-04-2-P				
41 Connection via four-core cable		•		
50 Connection EN 175301-803	•			
51 Connection EN 175301-803, transparent base with lamps 24 Vdc			•	
52 Connection EN 175301-803, transparent base with lamps 110 Vdc			•	
53 Connection EN 175301-803, transparent base with lamps 230 Vdc			•	
71 Connection IEC 61076-2-101 D (M12), black base with lamps 24 Vdc			•	

Option
P01 MP Filtri standard
Pxx Customized

DEA*50	
Electrical Differential Indicator	
Settings	Ordering code
1.2 bar $\pm 10\%$	DE A 12 x A 50 P01
2.0 bar $\pm 10\%$	DE A 20 x A 50 P01

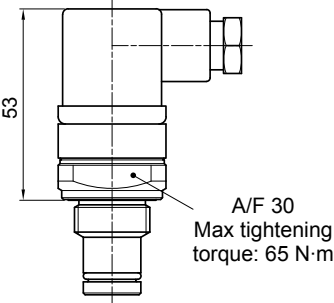

Hydraulic symbol

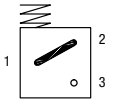

Electrical symbol

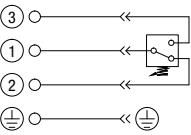

Materials

- Body: Brass
- Base: Black Nylon
- Contacts: Silver
- Seal: HNBR - FPM

Technical data

- Max working pressure: 420 bar
- Proof pressure: 630 bar
- Burst pressure: 1260 bar
- Working temperature: From -25 °C to +110 °C
- Compatibility with fluids: Mineral oils, Synthetic fluids HFA, HFB, HFC according to ISO 2943
- Degree protection: IP66 according to EN 60529
IP69K according to ISO 20653

Electrical data

- Electrical connection: EN 175301-803
- Resistive load: 0.2 A / 115 Vdc

DEM*10	
Electrical Differential Indicator	
Settings	Ordering code
1.2 bar $\pm 10\%$	DE M 12 x x 10 P01
2.0 bar $\pm 10\%$	DE M 20 x x 10 P01

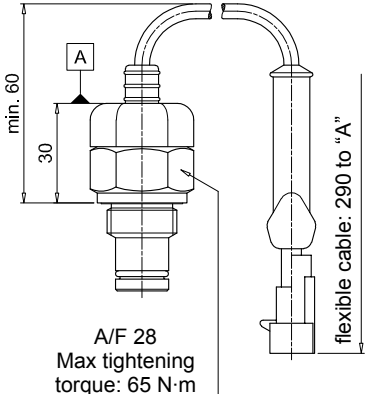

Hydraulic symbol

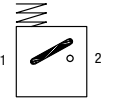

Electrical symbol

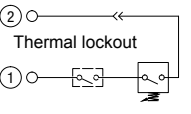

Materials

- Body: Brass
- Base: Black Nylon
- Contacts: Silver
- Seal: HNBR - FPM

Technical data

- Max working pressure: 420 bar
- Proof pressure: 630 bar
- Burst pressure: 1260 bar
- Working temperature: From -25 °C to +110 °C
- Compatibility with fluids: Mineral oils, Synthetic fluids HFA, HFB, HFC according to ISO 2943
- Degree protection: IP66 according to EN 60529

Electrical data

- Electrical connection: AMP Superseal series 1.5
- Resistive load: 0.2 A / 115 Vdc
- Switching type: Normally open contacts (NC on request)
- Thermal lockout: Normally open up to 30 °C (option "F")

DEM*20	
Electrical Differential Indicator	
Settings	Ordering code
1.2 bar $\pm 10\%$	DE M 12 x x 20 P01
2.0 bar $\pm 10\%$	DE M 20 x x 20 P01

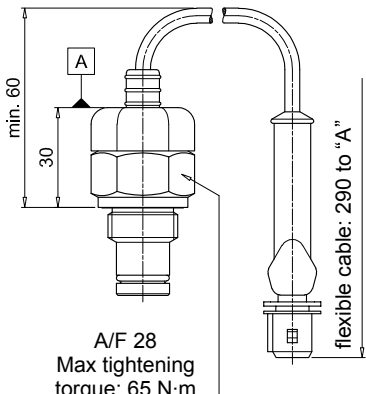

Hydraulic symbol

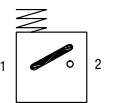

Electrical symbol

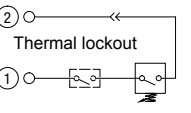

Materials

- Body: Brass
- Base: Black Nylon
- Contacts: Silver
- Seal: HNBR - FPM

Technical data

- Max working pressure: 420 bar
- Proof pressure: 630 bar
- Burst pressure: 1260 bar
- Working temperature: From -25 °C to +110 °C
- Compatibility with fluids: Mineral oils, Synthetic fluids HFA, HFB, HFC according to ISO 2943
- Degree protection: IP66 according to EN 60529

Electrical data

- Electrical connection: AMP Time junior
- Resistive load: 0.2 A / 115 Vdc
- Switching type: Normally open contacts (NC on request)
- Thermal lockout: Normally open up to 30 °C (option "F")

DIFFERENTIAL INDICATORS

Dimensions

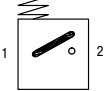
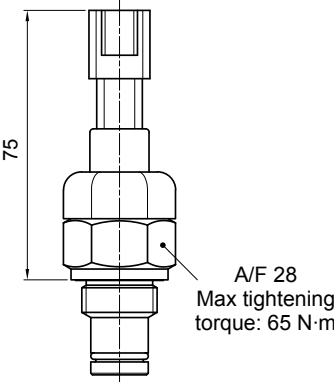
DEM*30		Hydraulic symbol 	Materials - Body: Brass - Base: Black Nylon - Contacts: Silver - Seal: HNBR - FPM	
Electrical Differential Indicator				Technical data - Max working pressure: 420 bar - Proof pressure: 630 bar - Burst pressure: 1260 bar - Working temperature: From -25 °C to +110 °C - Compatibility with fluids: Mineral oils, Synthetic fluids HFA, HFB, HFC according to ISO 2943 - Degree protection: IP66 according to EN 60529
Settings	Ordering code			
1.2 bar ±10%	DE M 12 x x 30 P01			
2.0 bar ±10%	DE M 20 x x 30 P01	Electrical data - Electrical connection: Deutsch DT-04-2-P - Resistive load: 0.2 A / 115 Vdc - Switching type: Normally open contacts (NC on request) - Thermal lockout: Normally open up to 30 °C (option "F")		
				

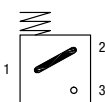
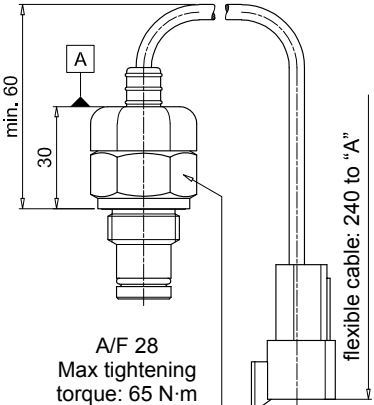
DEM*35		Hydraulic symbol 	Materials - Body: Brass - Base: Black Nylon - Contacts: Silver - Seal: HNBR - FPM	
Electrical Differential Indicator				Technical data - Max working pressure: 420 bar - Proof pressure: 630 bar - Burst pressure: 1260 bar - Working temperature: From -25 °C to +110 °C - Compatibility with fluids: Mineral oils, Synthetic fluids HFA, HFB, HFC according to ISO 2943 - Degree protection: IP66 according to EN 60529
Settings	Ordering code			
1.2 bar ±10%	DE M 12 x x 35 P01			
2.0 bar ±10%	DE M 20 x x 35 P01	Electrical data - Electrical connection: Deutsch DT-04-3-P - Resistive load: 0.2 A / 115 Vdc - Switching type: SPDT contact - Thermal lockout: Normally open up to 30 °C (option "F")		
				

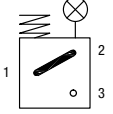
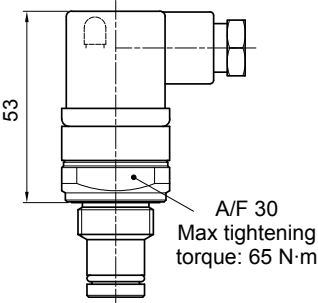
DLA*51 - DLA*52		Hydraulic symbol 	Materials - Body: Brass - Base: Transparent Nylon - Contacts: Silver - Seal: HNBR - FPM	
Electrical/Visual Differential Indicator				Technical data - Max working pressure: 420 bar - Proof pressure: 630 bar - Burst pressure: 1260 bar - Working temperature: From -25 °C to +110 °C - Compatibility with fluids: Mineral oils, Synthetic fluids HFA, HFB, HFC according to ISO 2943 - Degree protection: IP66 according to EN 60529 IP69K according to ISO 20653
Settings	Ordering code			
1.2 bar ±10%	DL A 12 x A xx P01			
2.0 bar ±10%	DL A 20 x A xx P01	Electrical data - Electrical connection: EN 175301-803 - Type: 51 52 - Lamps: 24 Vdc 110 Vdc - Resistive load: 1 A / 24 Vdc 1 A / 110 Vdc		
				

DLA*71	
Electrical/Visual Differential Indicator	
Settings	Ordering code
1.2 bar \pm 10%	DL A 12 x A 71 P01
2.0 bar \pm 10%	DL A 20 x A 71 P01

Hydraulic symbol

Electrical symbol

Materials

- Body: Brass
- Base: Black Nylon
- Contacts: Silver
- Seal: HNBR - FPM

Technical data

- Max working pressure: 420 bar
- Proof pressure: 630 bar
- Burst pressure: 1260 bar
- Working temperature: From -25 °C to +110 °C
- Compatibility with fluids: Mineral oils, Synthetic fluids
HFA, HFB, HFC according to ISO 2943
- Degree protection: IP65 according to EN 60529
IP69K according to ISO 20653

Electrical data

- Electrical connection: IEC 61076-2-101 D (M12)
- Lamps: 24 Vdc
- Resistive load: 0.4 A / 24 Vdc

DLE*A50	
Electrical/Visual Differential Indicator	
Settings	Ordering code
1.2 bar \pm 10%	DL E 12 x A 50 P01
2.0 bar \pm 10%	DL E 20 x A 50 P01

Hydraulic symbol

Electrical symbol

Materials

- Body: Brass
- Base: Black Nylon
- Contacts: Silver
- Seal: HNBR - FPM

Technical data

- Max working pressure: 420 bar
- Proof pressure: 630 bar
- Burst pressure: 1260 bar
- Working temperature: From -25 °C to +110 °C
- Compatibility with fluids: Mineral oils, Synthetic fluids
HFA, HFB, HFC according to ISO 2943
- Degree protection: IP65 according to EN 60529

Electrical data

- Electrical connections: EN 175301-803
- Resistive load: 5 A / 250 Vac
- Available the connector with lamps

DLE*F50	
Electrical/Visual Differential Indicator	
Settings	Ordering code
1.2 bar \pm 10%	DL E 12 x F 50 P01
2.0 bar \pm 10%	DL E 20 x F 50 P01

Hydraulic symbol

Electrical symbol

Materials

- Body: Brass
- Base: Black Nylon
- Contacts: Silver
- Seal: HNBR - FPM

Technical data

- Max working pressure: 420 bar
- Proof pressure: 630 bar
- Burst pressure: 1260 bar
- Working temperature: From -25 °C to +110 °C
- Compatibility with fluids: Mineral oils, Synthetic fluids
HFA, HFB, HFC according to ISO 2943
- Degree protection: IP65 according to EN 60529

Electrical data

- Electrical connections: EN 175301-803
- Resistive load: 5 A / 250 Vac
- Thermal lockout setting: +30 °C

DIFFERENTIAL INDICATORS

Dimensions

DTA*70	
Electronic Differential Indicator	
Settings	Ordering code
1.2 bar $\pm 10\%$	DT A 12 x x 70 P01
2.0 bar $\pm 10\%$	DT A 20 x x 70 P01

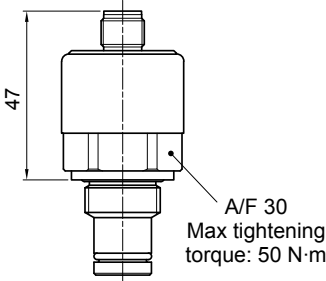

A/F 30
Max tightening torque: 50 N-m

Hydraulic symbol

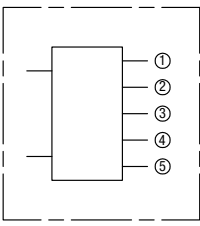

Electrical symbol

①	○	○	+24 Vdc
②	○	○	4 ÷ 20 mA
③	○	○	75% - N.O. Digital output
④	○	○	100% - N.O. Digital output
⑤	○	○	0 Vdc

Materials

- Body: Brass
- Internal parts: Brass - Nylon
- Contacts: Silver
- Seal: HNBR - FPM

Technical data

- Max working pressure: 420 bar
- Proof pressure: 630 bar
- Burst pressure: 1260 bar
- Compatibility with fluids: Mineral oils, Synthetic fluids HFA, HFB, HFC according to ISO 2943
- Degree protection: IP67 according to EN 60529

Electrical data

- Electrical connection: IEC 61076-2-101 D (M12)
- Power supply: 24 Vdc
- Analogue output: From 4 to 20 mA
- Thermal lockout: 30 °C (all output signals stalled up to 30 °C)



DVA	
Visual Differential Indicator	
Settings	Ordering code
1.2 bar $\pm 10\%$	DV A 12 x P01
2.0 bar $\pm 10\%$	DV A 20 x P01

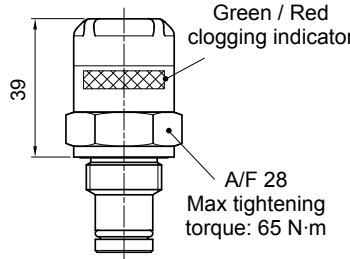

Green / Red clogging indicator

A/F 28
Max tightening torque: 65 N-m

Hydraulic symbol

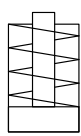

Materials

- Body: Brass
- Internal parts: Brass - Nylon
- Contacts: Silver
- Seal: HNBR - FPM

Technical data

- Reset: Automatic reset
- Max working pressure: 420 bar
- Proof pressure: 630 bar
- Burst pressure: 1260 bar
- Working temperature: From -25 °C to +110 °C
- Compatibility with fluids: Mineral oils, Synthetic fluids HFA, HFB, HFC according to ISO 2943
- Degree protection: IP65 according to EN 60529

DVM	
Visual Differential Indicator	
Settings	Ordering code
1.2 bar $\pm 10\%$	DV M 12 x P01
2.0 bar $\pm 10\%$	DV M 20 x P01

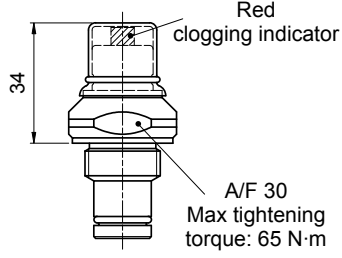

Red clogging indicator

A/F 30
Max tightening torque: 65 N-m

Hydraulic symbol

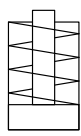

Materials

- Body: Brass
- Internal parts: Brass - Nylon
- Contacts: Silver
- Seal: HNBR - FPM

Technical data

- Reset: Manual reset
- Max working pressure: 420 bar
- Proof pressure: 630 bar
- Burst pressure: 1260 bar
- Working temperature: From -25 °C to +110 °C
- Compatibility with fluids: Mineral oils, Synthetic fluids HFA, HFB, HFC according to ISO 2943
- Degree protection: IP65 according to EN 60529

T2		Materials - Body: Phosphatized steel - Seal: HNBR / FPM				
Indicator plug						
<table border="1" style="width: 100%; border-collapse: collapse;"> <thead> <tr> <th style="width: 50%;">Seal</th> <th style="width: 50%;">Ordering code</th> </tr> </thead> <tbody> <tr> <td style="text-align: center;">HNBR</td> <td style="text-align: center;">T2 H</td> </tr> <tr> <td style="text-align: center;">FPM</td> <td style="text-align: center;">T2 V</td> </tr> </tbody> </table>	Seal		Ordering code	HNBR	T2 H	FPM
Seal	Ordering code					
HNBR	T2 H					
FPM	T2 V					

DESIGNATION & ORDERING CODE - DIFFERENTIAL INDICATORS

Series	Configuration example 1:	DE	M	12	H	F	50	P01
DE Electrical differential indicator	Configuration example 2:	DL	E	20	V	A	71	P01
DL Electrical/Visual differential indicator	Configuration example 3:	DT	A	12	H	F	70	P01
DT Electronic differential indicator	Configuration example 4:	DV	M	20	V			P01
DV Visual differential indicator								

Type	DE	DL	DT	DV	
A Standard type	•	•	•	•	A With automatic reset
M With wired electrical connection	•				M With manual reset
E For high power supply		•			

Pressure setting	
12 1.2 bar	
20 2.0 bar	

Seals	
H HNBR	
V FPM	

Thermostat	DEA	DEM	DLA	DLE	DT	DV	
A Without	•	•	•	•			
F With thermostat		•		•	•		

Electrical connections	DEA	DEM	DLA	DLE	DT	DV	
10 Connection AMP Superseal series 1.5		•					
20 Connection AMP Timer Junior		•					
30 Connection Deutsch DT-04-2-P		•					
35 Connection Deutsch DT-04-3-P		•					
50 Connection EN 175301-803	•			•			
51 Connection EN 175301-803, transparent base with lamps 24 Vdc			•				
52 Connection EN 175301-803, transparent base with lamps 110 Vdc			•				
70 Connection IEC 61076-2-101 D (M12)					•		
71 Connection IEC 61076-2-101 D (M12), black base with lamps 24 Vdc			•				

Option	
P01 MP Filtri standard	
Pxx Customized	

DESIGNATION & ORDERING CODE - DIFFERENTIAL INDICATOR PLUG

Series	Configuration example	T2	H
T2 Indicator plug			

Seals	
H HNBR	
V FPM	

Clogging indicators are devices that check the life time of the filter elements. They measure the pressure drop through the filter element directly connected to the filter housing.

These devices trip when the clogging of the filter element causes a pressure drop increasing across the filter element.

Filter elements are efficient only if their Dirt Holding Capacity is fully exploited.

This is achieved by using filter housings equipped with clogging indicators.

The indicator is set to alarm before the element becomes fully clogged.

MP Filtri can supply indicators of the following designs:

- Vacuum switches and gauges**
- Pressure switches and gauges**
- Differential pressure indicators**

These type of devices can be provided with a visual, electrical or both signals.

The electronic differential pressure clogging indicator is also available.

It provides both analogical 4-20 mA output and digital warning (75% of clogging) and alarm (clogging) outputs.

Clogging Indicators



Clogging indicators



Suitable indicator types

VACUUM INDICATORS

Vacuum indicators are used on the Suction line to check the efficiency of the filter element.

They measure the pressure downstream of the filter element.

Standard items are produced with R 1/4" EN 10226 connection.

Available products with R 1/8" EN 10226 to be fitted on MPS series.

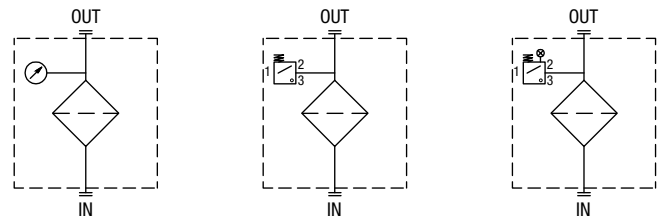

BAROMETRIC INDICATORS

Pressure indicators are used on the Return line to check the efficiency of the filter element.

They measure the pressure upstream of the filter element.

Standard items are produced with R 1/8" EN 10226 connection.

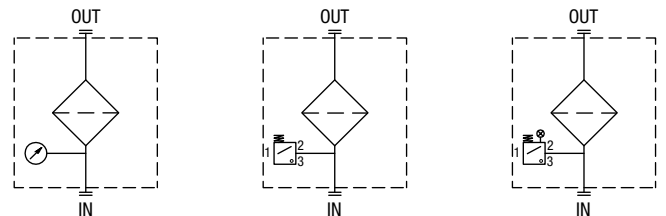

DIFFERENTIAL INDICATORS

Differential indicators are used on the Pressure line to check the efficiency of the filter element.

They measure the pressure upstream and downstream of the filter element (differential pressure).

Standard items are produced with special connection G 1/2" size.

Also available in Stainless Steel models.

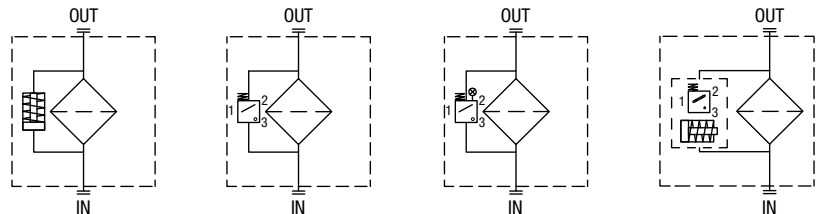

Filter family	Filter series	Electrical indicator	Electrical / Visual indicator	Electronic indicator	Visual indicator
SUCTION FILTERS	ELIXIR® SFEX060-080-110-160	VEB21AA50P01	VLB21AA51P01 VLB21AA52P01 VLB21AA53P01 VLB21AA71P01		VVB16P01 VVS16P01
	SF2 250 - 350 SF2 500 - 501 - 503 - 504 - 505 SF2 510 - 535 - 540	VEA21AA50P01	VLA21AA51P01 VLA21AA52P01 VLA21AA53P01 VLA21AA71P01		VVA16P01 VVR16P01
RETURN FILTERS	With bypass valve ELIXIR® RFEX060-080-110-160	BEA15HA50P01 BEM15HA41P01	BLA15HA51P01 BLA15HA52P01 BLA15HA53P01 BLA15HA71P01		BVA14P01 BVR14P01 BVP15HP01 BVQ15HP01
	Without bypass valve ELIXIR® RFEX060-080-110-160	BEA20HA50P01 BEM20HA41P01	BLA20HA51P01 BLA20HA52P01 BLA20HA53P01 BLA20HA71P01		BVA25P01 BVR25P01 BVP20HP01 BVQ20HP01
	With bypass valve MPFX-MPTX-MPF-MPT - bypass 1.75 bar MPH - bypass 1.75 bar RF2250 - RF2350 - bypass 1.75 bar	BEA15HA50P01 BEM15HA41P01	BLA15HA51P01 BLA15HA52P01 BLA15HA53P01 BLA15HA71P01		BVA14P01 BVR14P01 BVP15HP01 BVQ15HP01
	With bypass valve MPFX-MPTX-MPF-MPT - bypass 3 bar MPH - bypass 2.5 bar FRI 255 RF2250 - RF2350 - bypass 3 bar	BEA20HA50P01 BEM20HA41P01	BLA20HA51P01 BLA20HA52P01 BLA20HA53P01 BLA20HA71P01		BVA25P01 BVR25P01 BVP20HP01 BVQ20HP01
MPLX FRI 025 - 040 - 100 - 250 - 630 - 850	DEA20xA50P01 DEM20xA10P01 DEM20xA20P01 DEM20xA30P01 DEM20xA35P01	DLA20xA51P01 DLA20xA52P01 DLA20xA71P01 DLE20xA50P01 DLE20xF50P01	DTA20xF70P01	DVA20xP01 DVM20xP01	
RETURN / SUCTION FILTERS	Suction line MRSX 116 - 165 - 166	VEB21AA50P01	VLB21AA51P01 VLB21AA52P01 VLB21AA53P01 VLB21AA71P01		VVB16P01 VVS16P01
	Return line MRSX 116 - 165 - 166 LMP 124 MULTIPORT	BEA25HA50P01 BEM25HA41P01 BET25HF10P01 BET25HF30P01 BET25HF50P01	BLA25HA51P01 BLA25HA52P01 BLA25HA53P01 BLA25HA71P01		BVA25P01 BVR25P01 BVP20HP01 BVQ20HP01
SPIN-ON FILTERS	Suction line MPS 050 - 070 - 100 - 150 MPS 200 - 250 - 300 - 350	VEB21AA50P01	VLB21AA51P01 VLB21AA52P01 VLB21AA53P01 VLB21AA71P01		VVB16P01 VVS16P01
	Return line MPS 050 - 070 - 100 - 150 MPS 200 - 250 - 300 - 350	BEA15HA50P01 BEM15HA41P01	BLA15HA51P01 BLA15HA52P01 BLA15HA53P01 BLA15HA71P01		BVA14P01 BVR14P01 BVP20HP01 BVQ20HP01
	In-line MPS 051 - 071 - 101 - 151 MPS 301 - 351 MSH 050 - 070 - 100 - 150	DEA12xA50P01 DEM12xAxxP01	DLA12xA51P01 DLA12xA52P01 DLA12xA71P01 DLE12xA50P01 DLE12xF50P01 DLE20xF50P01 DLE20xF50P01	DTA12xA70P01 DTA12xF70P01 DTA20xA70P01 DTA20xF70P01	DVA12xP01 DVM12xP01

Filter family	Filter series	Electrical indicator	Electrical / Visual indicator	Electronic indicator	Visual indicator	Hazardous area electronic indicator 		
LOW & MEDIUM PRESSURE FILTERS	With bypass valve	ELIXIR® LFEX060-080-110-160	DES25HA10P01 DES25HA30P01 DES25HA80P01			DVS25HP01		
	Without bypass valve	ELIXIR® LFEX060-080-110-160	DES40HA10P01 DES40HA30P01 DES40HA80P01			DVS40HP01		
		LMP 110 - 112 - 116 - 118 - 119 MULTIPORT LMP 120 - 122 - 123 MULTIPORT LMP 210 - 211 - LDP				DVS25HP01 DVS40HP01		
	With bypass valve	LMP 400 - 401 & 430 - 431 LMP 900 - 901 LMP 902 - 903 LMP 950 - 951 LMP 952 - 953 - 954 LMD 211 - 400 - 401 - 431 - 951 - LDD	DEA20xA50P01 DEM20xAxxP01	DLA20xA51P01 DLA20xA52P01 DLA20xA71P01 DLE20xA50P01 DLE20xF50P01	DTA20xF70P01	DVA20xP01 DVM20xP01		
	Without bypass valve	LMP 110 - 112 - 116 - 118 - 119 MULTIPORT LMP 120 - 122 - 123 MULTIPORT LMP 210 - 211 - LDP LMP 400 - 401 & 430 - 431 LMP 900 - 901 LMP 902 - 903 LMP 950 - 951 LMP 952 - 953 - 954 LMD 211 - 400 - 401 - 431 - 951 - LDD	DEA50xA50P01 DEM50xAxxP01	DLA50xA51P01 DLA50xA52P01 DLA50xA71P01 DLE50xA50P01 DLE50xF50P01	DTA50xF70P01	DVA50xP01 DVM50xP01		
	HIGH PRESSURE FILTERS	With bypass valve	FMP 039 - 065 - 135 - 320 FHP 010 - 011 - 065 - 135 - 350 - 500 FMM 050 - 150 FHA 051 FHM 006 - 007 - 010 - 050 - 065 - 135 - 320 - 500 FHB 050 - 065 - 135 - 320 FHF 325 FHD 021 - 051 - 326 - 333	DEA50xA50P01 DEM50xAxxP01	DLA50xA51P01 DLA50xA52P01 DLA50xA71P01 DLE50xA50P01 DLE50xF50P01	DTA50xF70P01	DVA50xP01 DVM50xP01	DEH50xA48P01 DEH50xA49P01 DEH50xA70P01 DEH70xA48P01 DEH70xA49P01 DEH70xA70P01
		Without bypass valve	FMP 039 - 065 - 135 - 320 FHP 010 - 011 - 065 - 135 - 350 - 500 FMM 050 - 150 FHA 051 FHM 006 - 007 - 010 - 050 - 065 - 135 - 320 - 500 FHB 050 - 065 - 135 - 320 FHF 325 FHD 021 - 051 - 326 - 333	DEA70xA50P01 DEM70xAxxP01 DEA95xA50P01 DEM95xAxxP01	DLA70xA51P01 DLA70xA52P01 DLA70xA71P01 DLE70xA50P01 DLE70xF50P01 DLA95xA51P01 DLA95xA52P01 DLE95xA50P01 DLE95xF50P01	DTA70xF70P01 DTA95xF70P01	DVA70xP01 DVM70xP01 DVA95xP01 DVM95xP01	DEH50xA48P01 DEH50xA49P01 DEH50xA70P01 DEH70xA48P01 DEH70xA49P01 DEH70xA70P01
		With bypass valve	FZH 010 - 011 - 039 FZP 039 - 136 FZX 011 FZB 039 FZM 039 FZD 051	DEX50xA50P01	DLX50xA51P01 DLX50xA52P01		DVX50xP01 DVG50xP01	DEH50xA48P01 DEH50xA49P01 DEH50xA70P01 DEH70xA48P01 DEH70xA49P01 DEH70xA70P01
			Without bypass valve	FZH 010 - 011 - 039 FZP 039 - 136 FZB 039 FZM 039 FZD 010 - 021 - 051	DEX70xA50P01 DEX95xA50P01	DLX70xA51P01 DLX70xA52P01 DLX95xA51P01		DVX70xP01 DVG70xP01 DVG95xP01

All data, details and words contained in this publication are provided for information purposes only.
MP Filtri reserves the right to make modifications to the models and versions of the described products at any time
for both technical and / or commercial reasons.

The colors and the pictures of the products are purely indicative.
Any reproduction, partial or total, of this document is strictly forbidden.
All rights are strictly reserved.



WORLDWIDE NETWORK

HEADQUARTERS

MP Filtri S.p.A.
Pessano con Bornago
Milano - Italy
+39 02 957031
sales@mpfiltri.it

BRANCH OFFICES

ITALFILTRI LLC
Moscow - Russia
+7 (495) 220 94 60
mpfiltrirussia@yahoo.com

MP Filtri Canada Inc.
Concord, Ontario - Canada
+1 905 303 1369
sales@mpfiltricanada.com

MP Filtri France SAS
Villeneuve la Garenne
France
+33 (0)1 40 86 47 00
sales@mpfiltrifrance.com

MP Filtri Germany GmbH
St. Ingbert - Germany
+49 (0) 6894 95652-0
sales@mpfiltri.de

MP Filtri India Pvt. Ltd.
Bangalore - India
+91 80 4147 7444 / +91 80 4146 1444
sales@mpfiltri.co.in

MP Filtri (Shanghai) Co., Ltd.
Shanghai - Minhang District - China
+86 21 58919916 116
sales@mpfiltrishanghai.com

MP Filtri U.K. Ltd.
Bourton on the Water
Gloucestershire - United Kingdom
+44 (0) 1451 822 522
sales@mpfiltri.co.uk

MP Filtri U.S.A. Inc.
Quakertown, PA - U.S.A.
+1 215 529 1300
sales@mpfiltriusa.com

PASSION TO PERFORM



mpfiltri.com